

GUJO
ADVENTURE



DEEP SEA SUBMARINE

AGES 7+

1 SEE PAGES 52 & 53 FOR A COMPLETE PARTS LIST

2 CHECK THE PANEL NUMBER

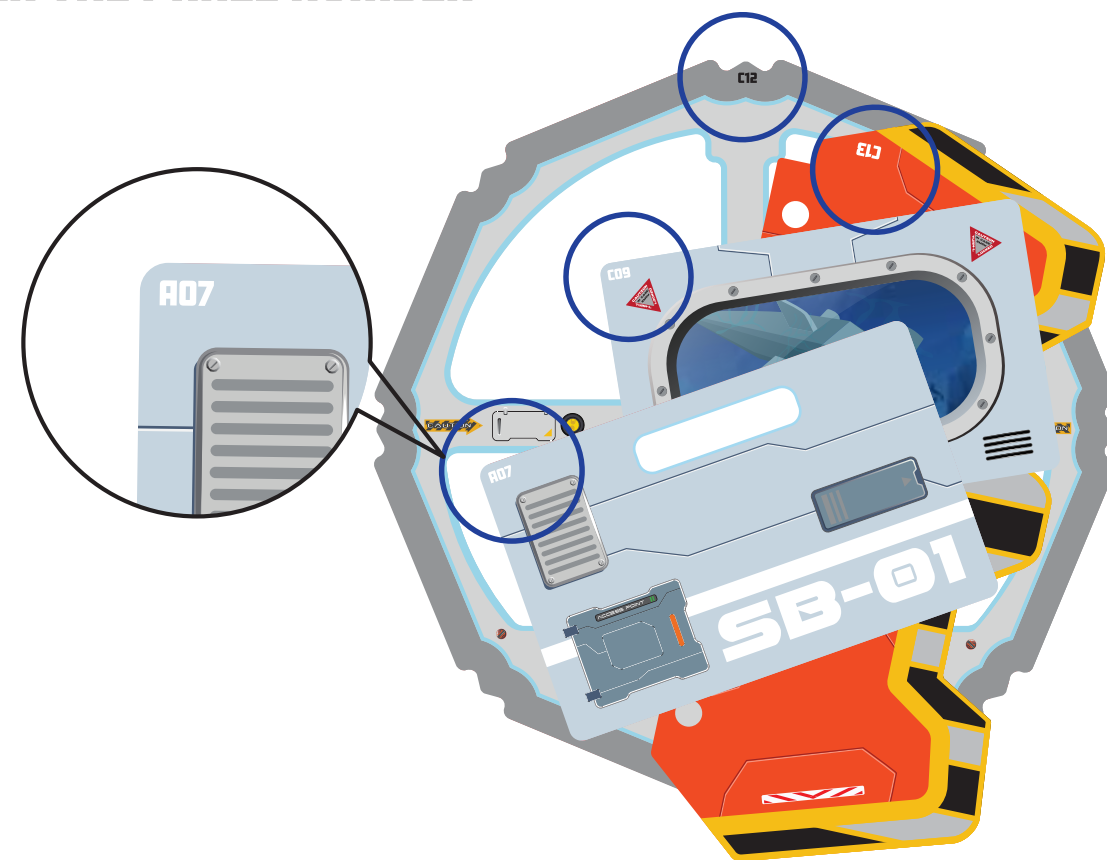

SLIDE THE PANEL INTO POSTS



**DEEP SEA
SUBMARINE**



A

STEP 1

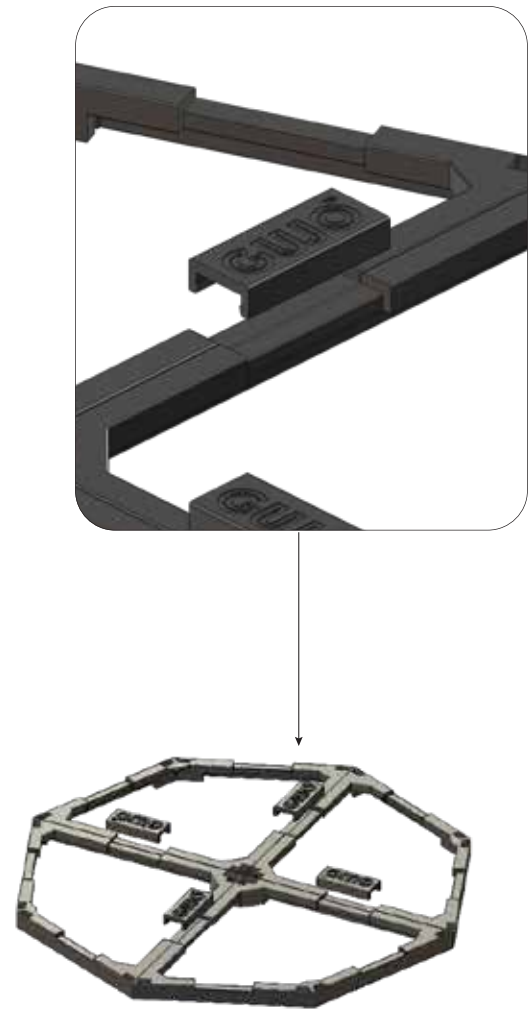
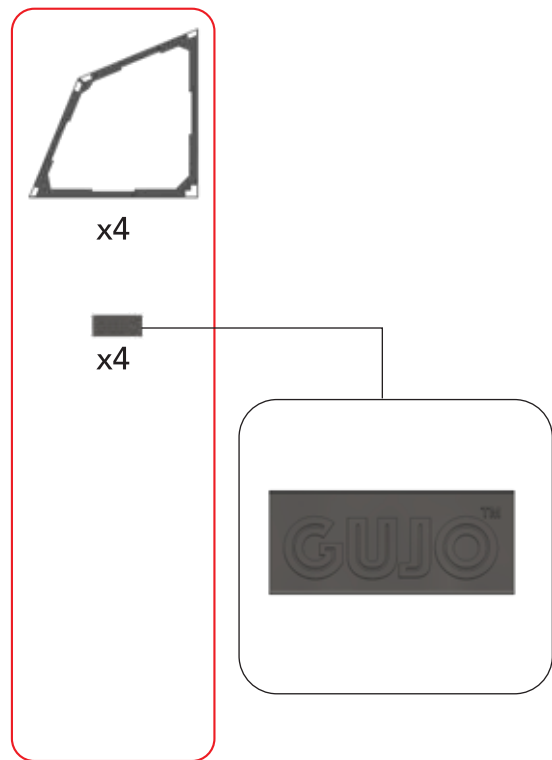

A

STEP 2

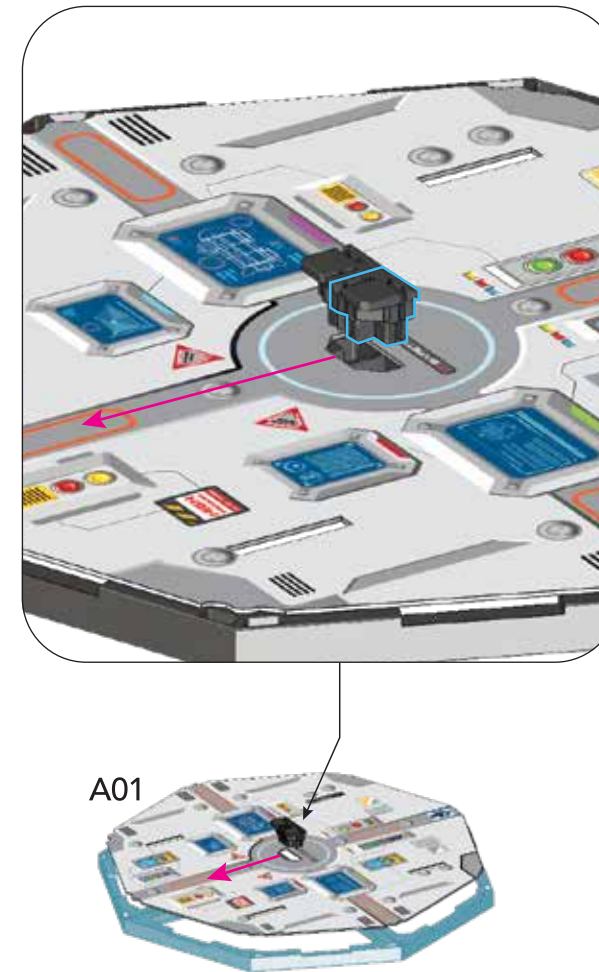
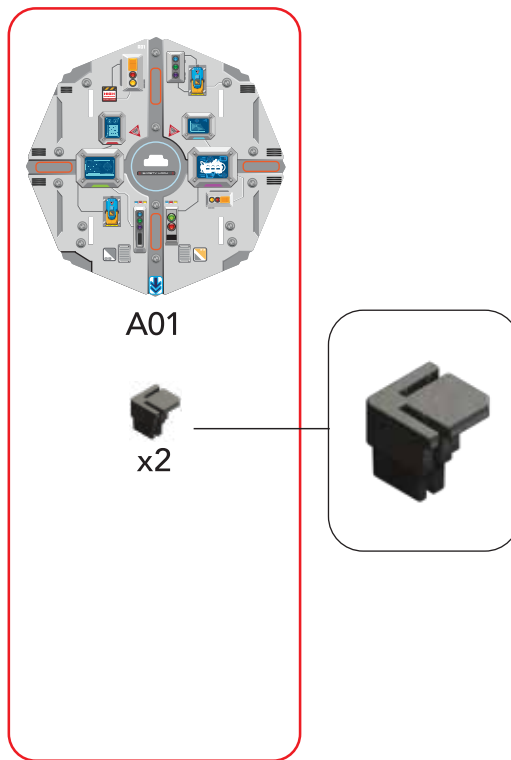

A

STEP 3

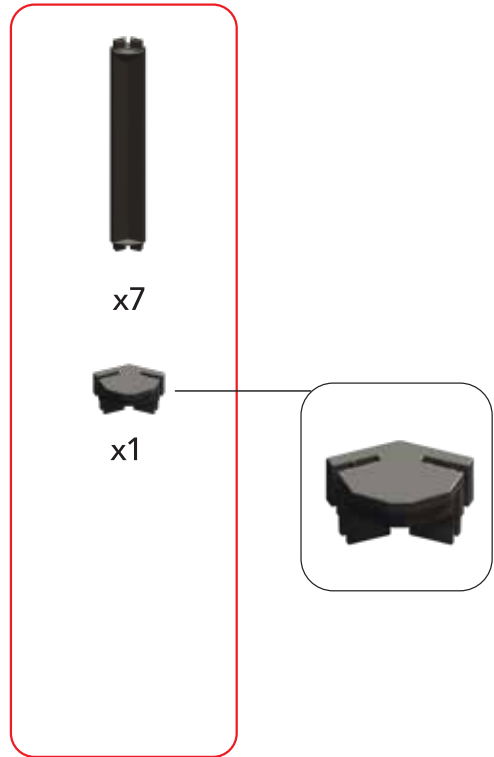

A

STEP 4

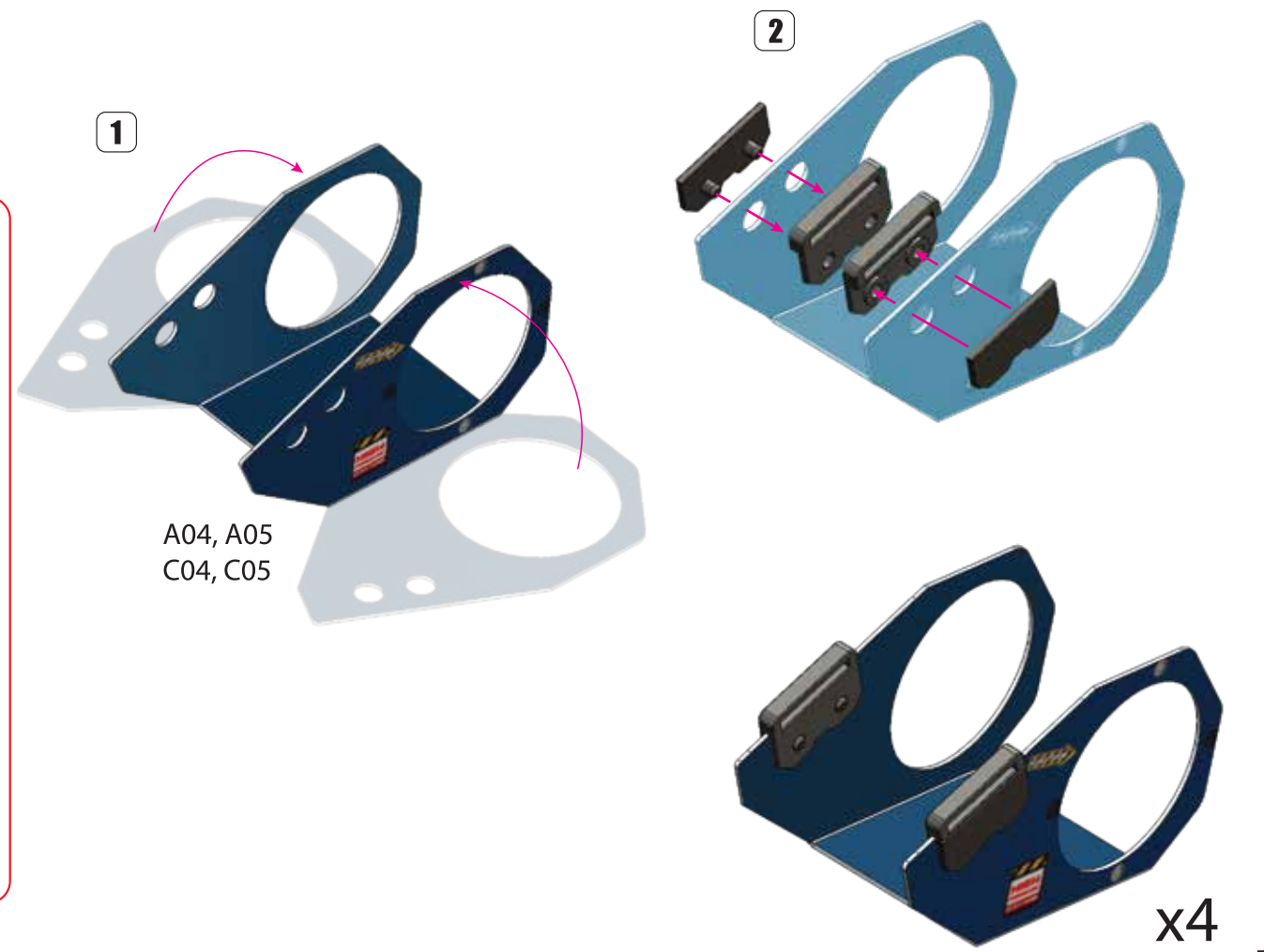

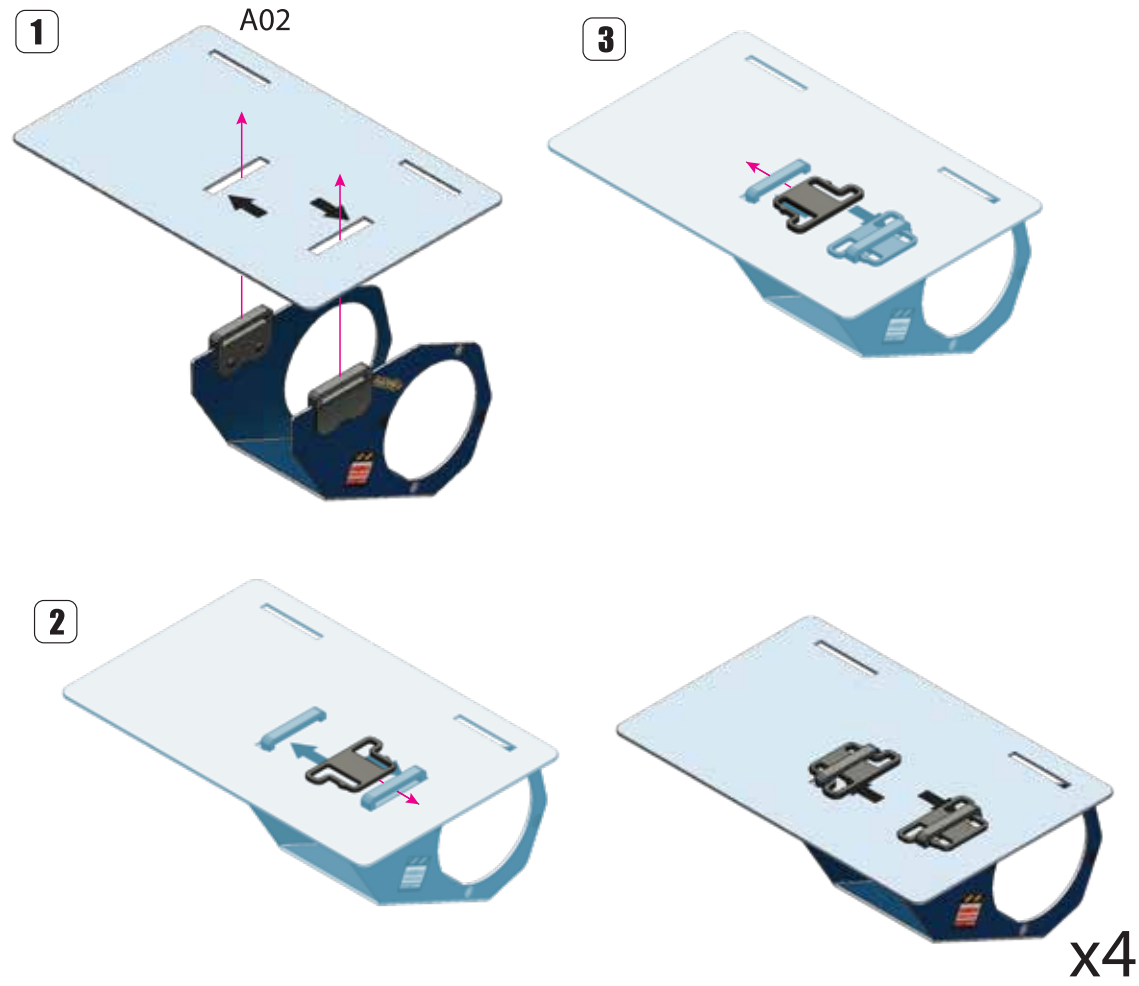
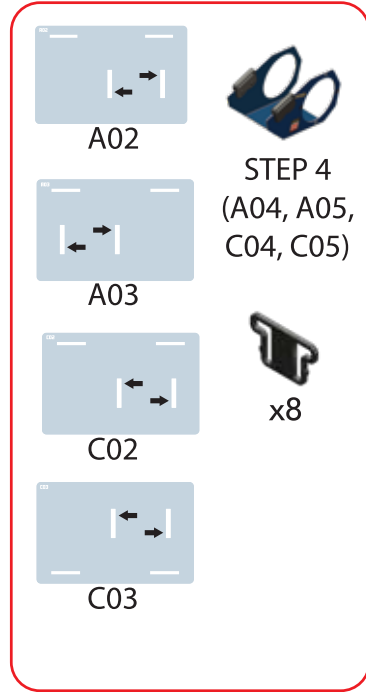
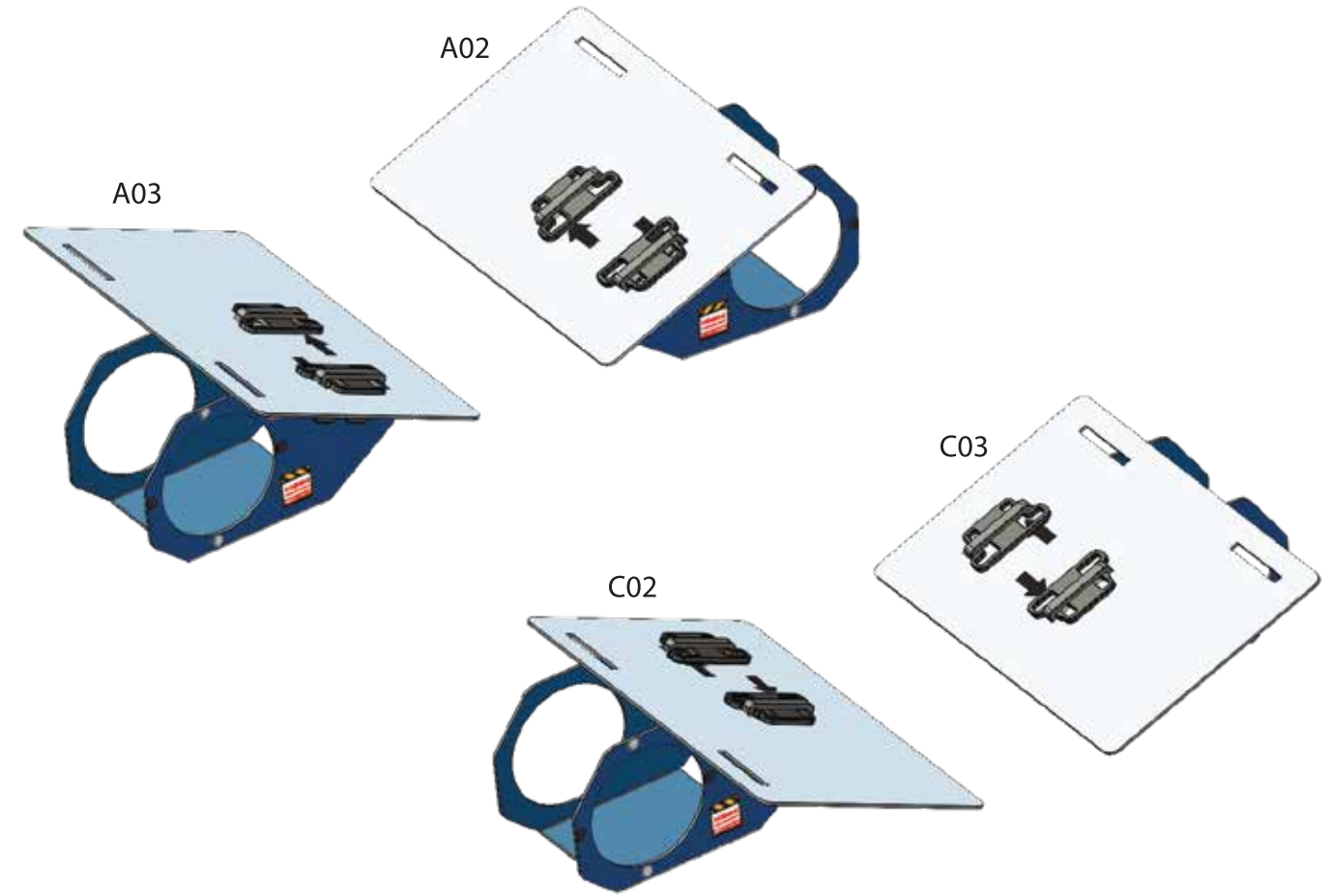
A**STEP 5****A****STEP 6**

A

STEP 7

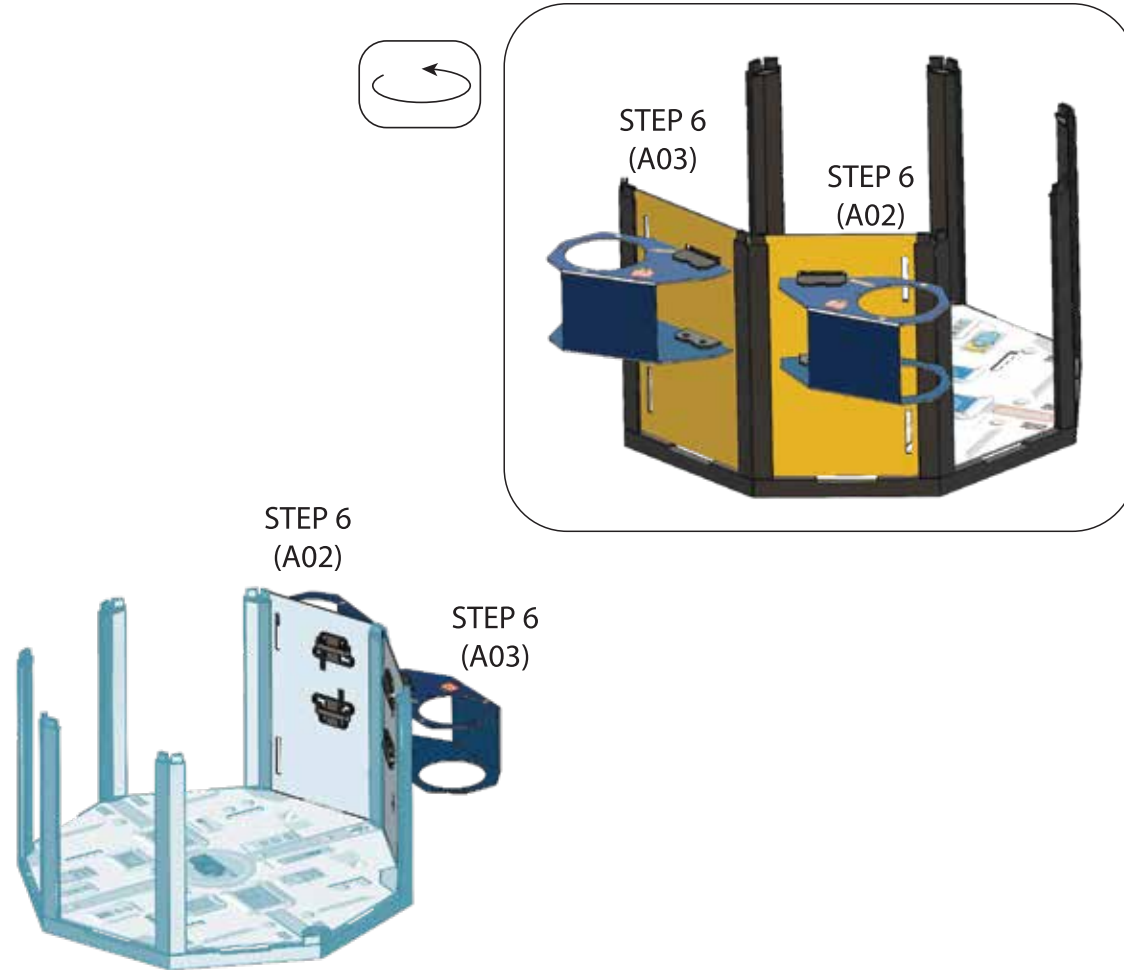
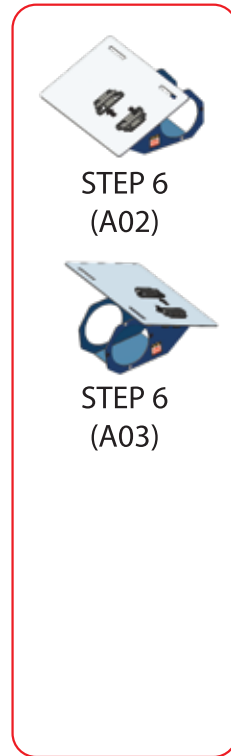

A

STEP 8

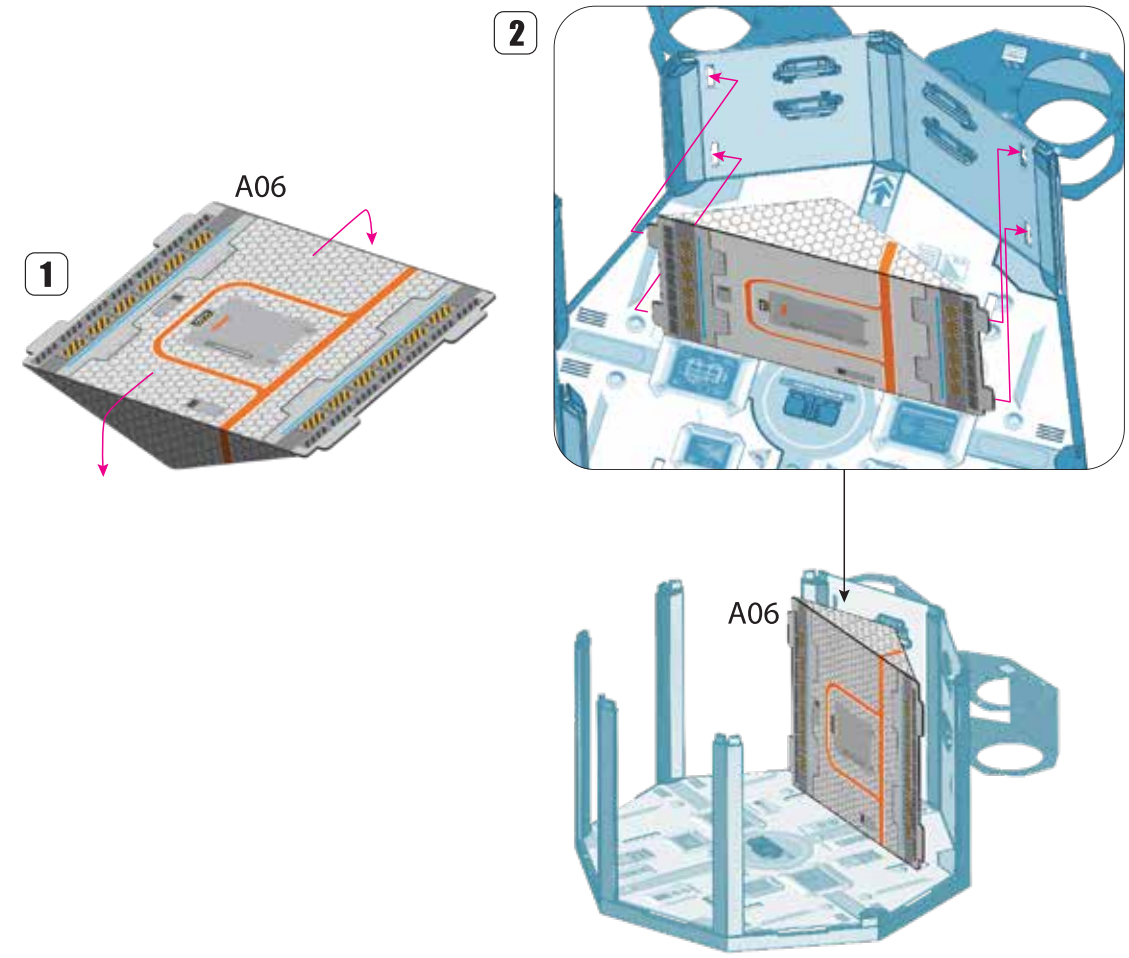
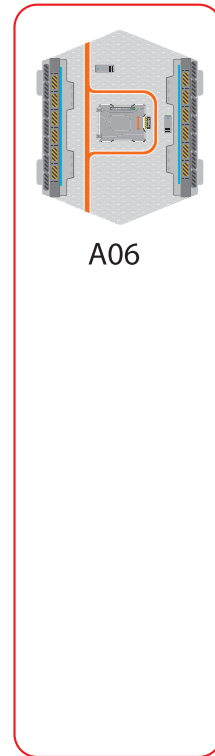

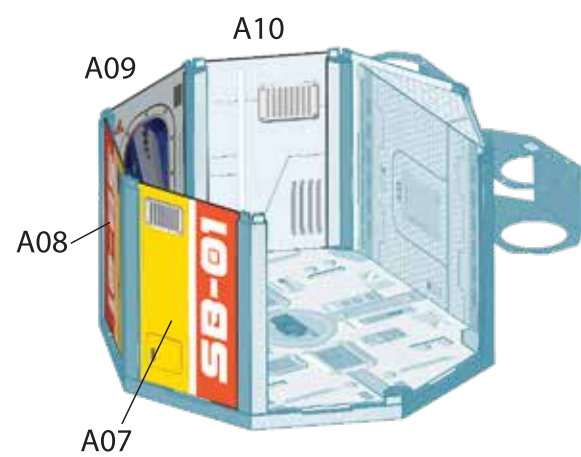
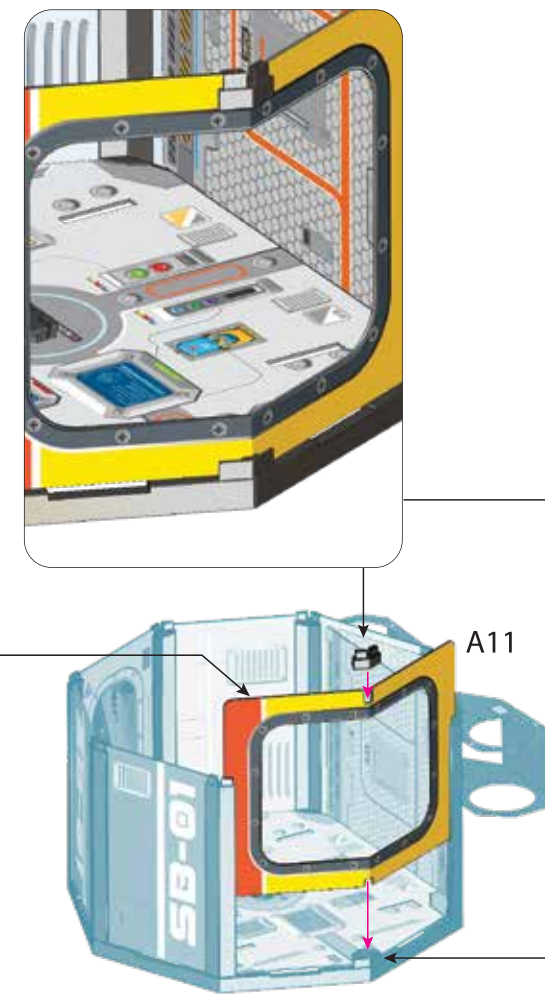
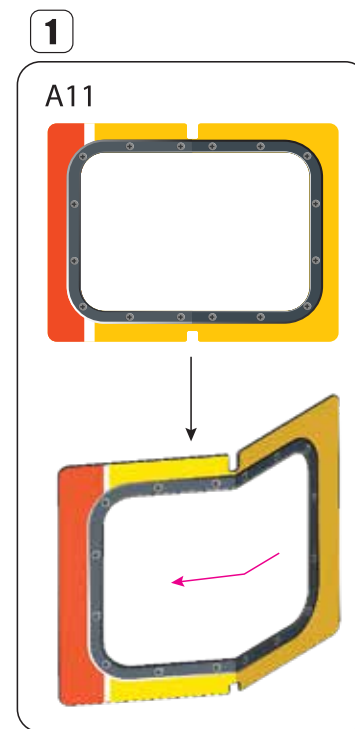
A**STEP
9****12****A****STEP
10****13**

A

**STEP
11**



x1

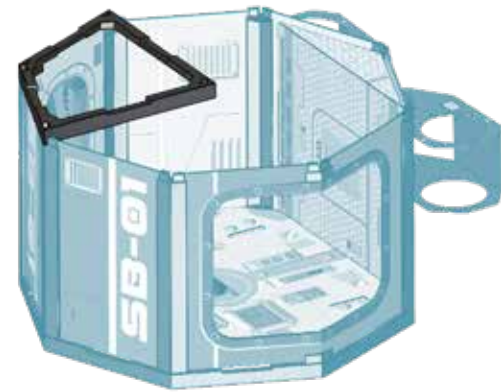

A

**STEP
12**

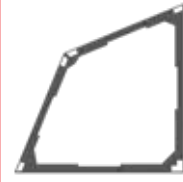

x1



x1

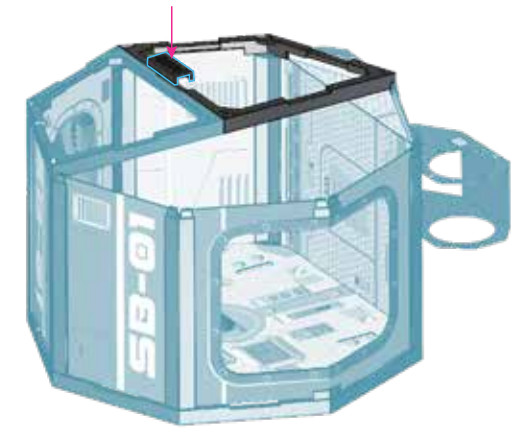

A

**STEP
13**

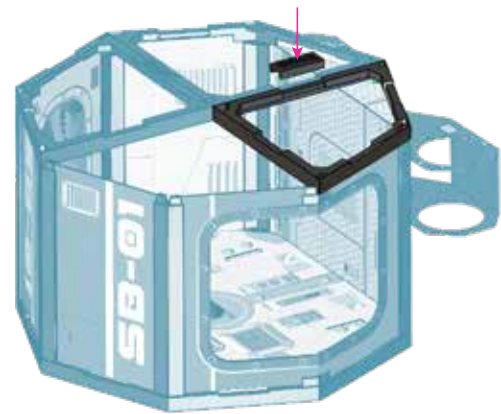
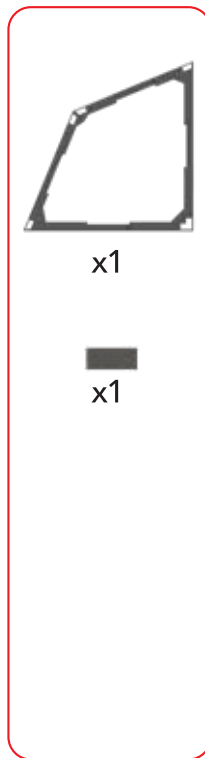

A

**STEP
14**

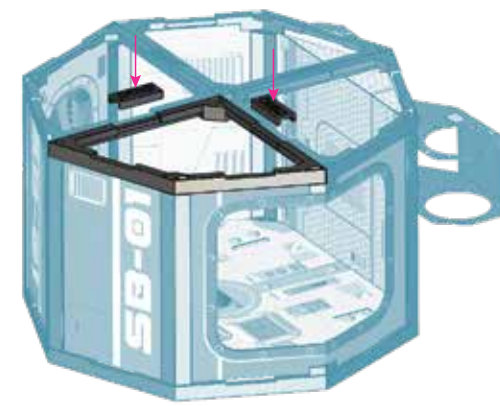
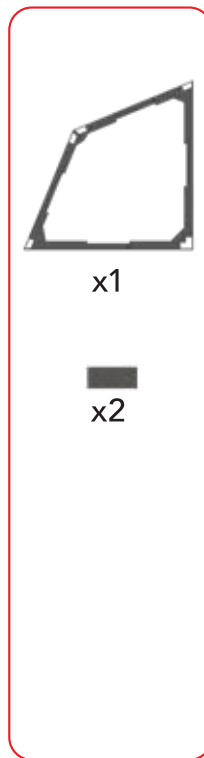

B

STEP 15

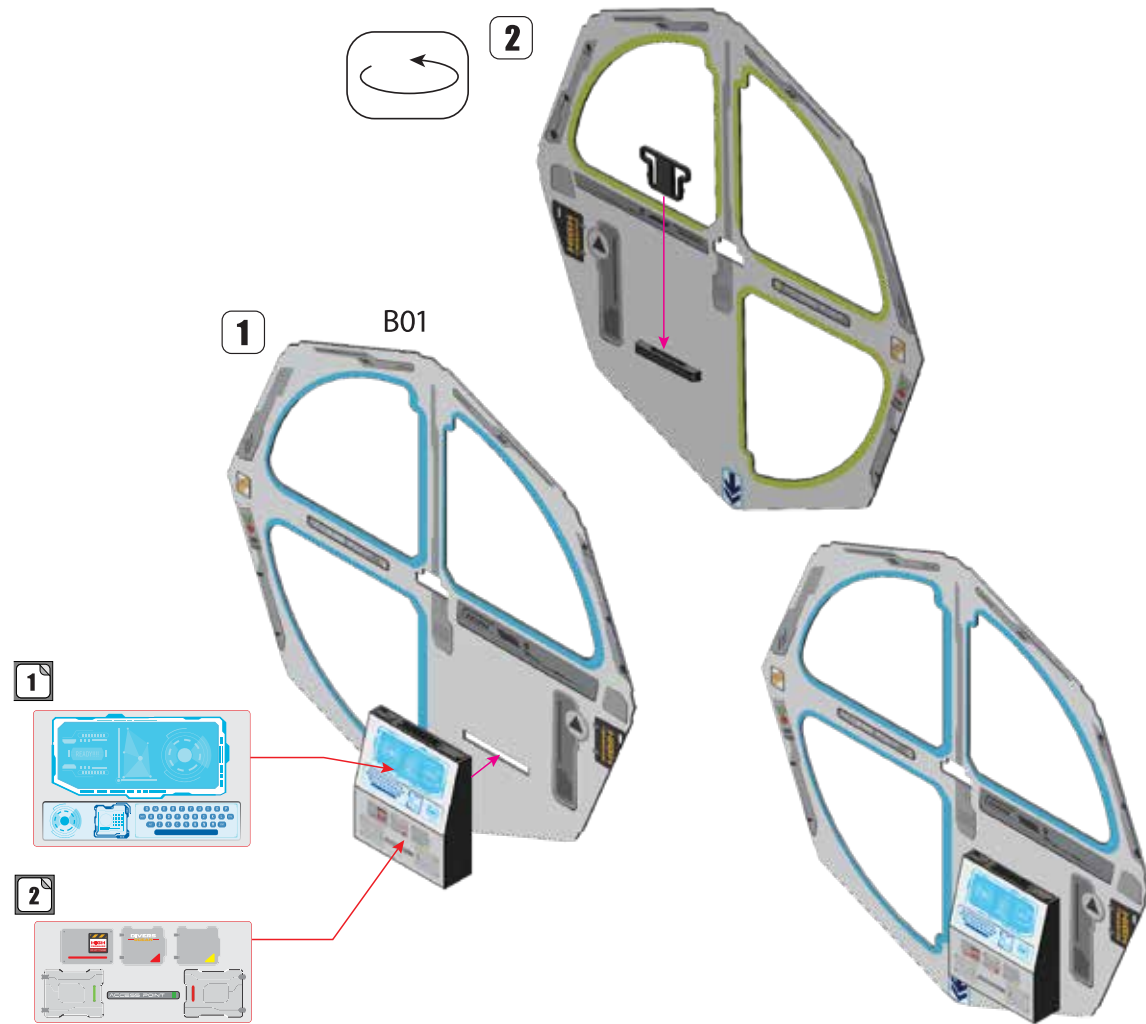
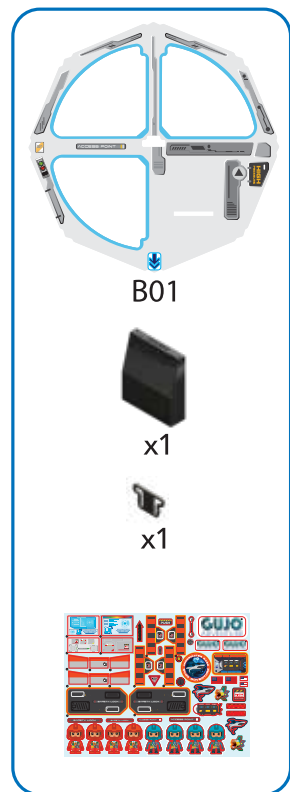

B

STEP 16

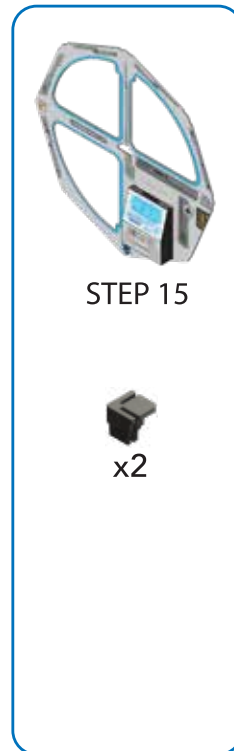

B

**STEP
17**

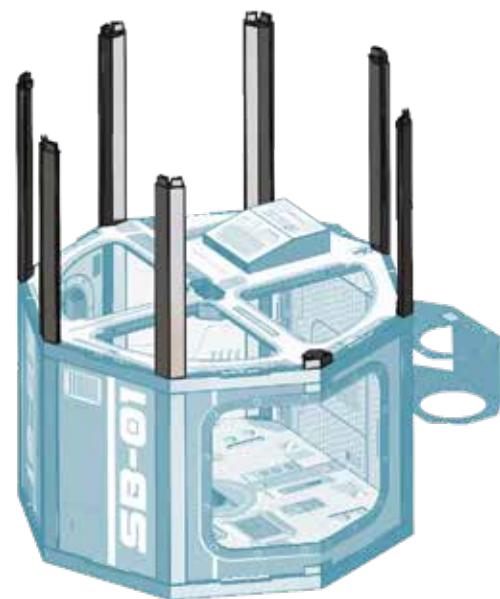
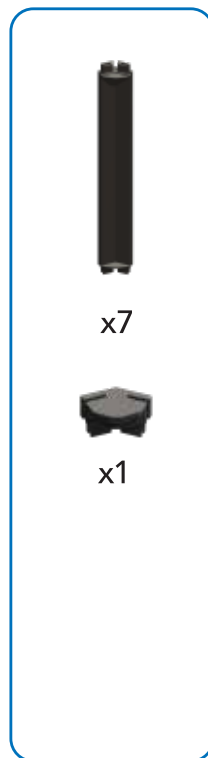

B

**STEP
18**

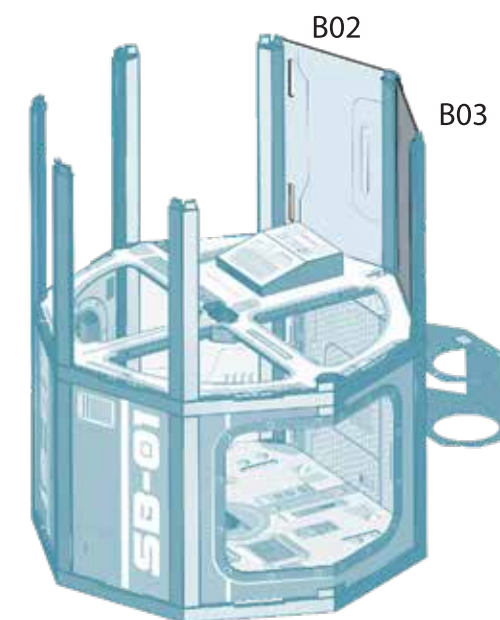
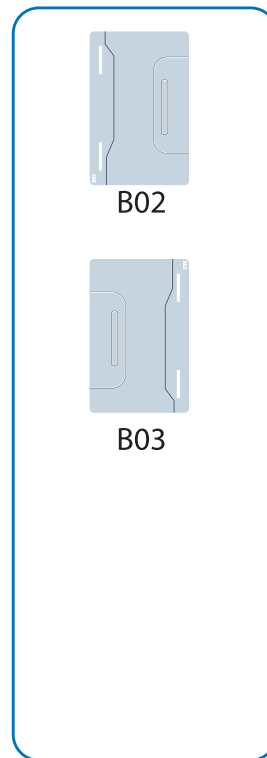

B

**STEP
19**

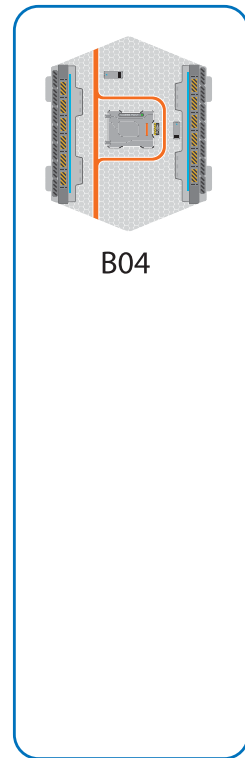

1

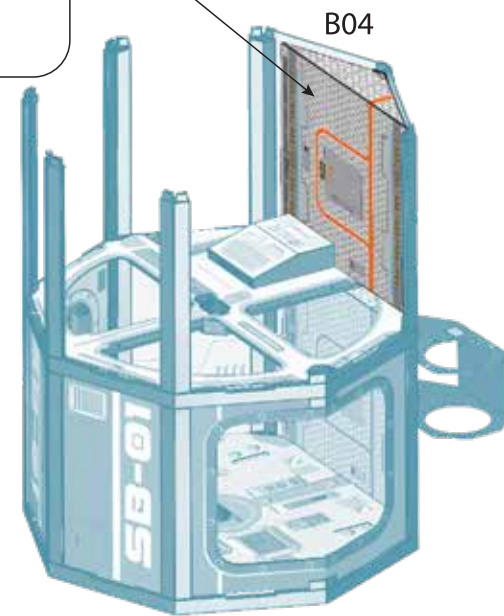
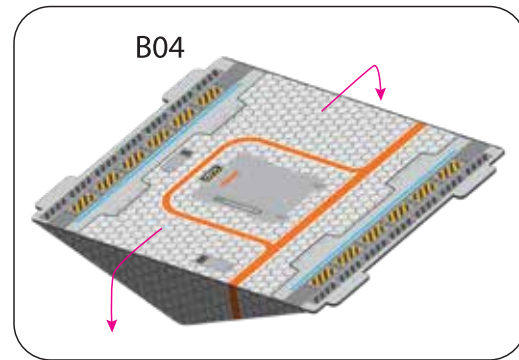

B

**STEP
20**

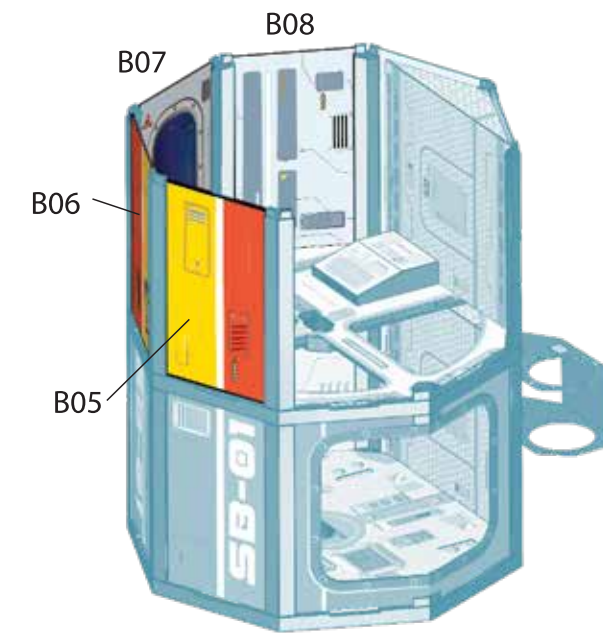

B

**STEP
21**

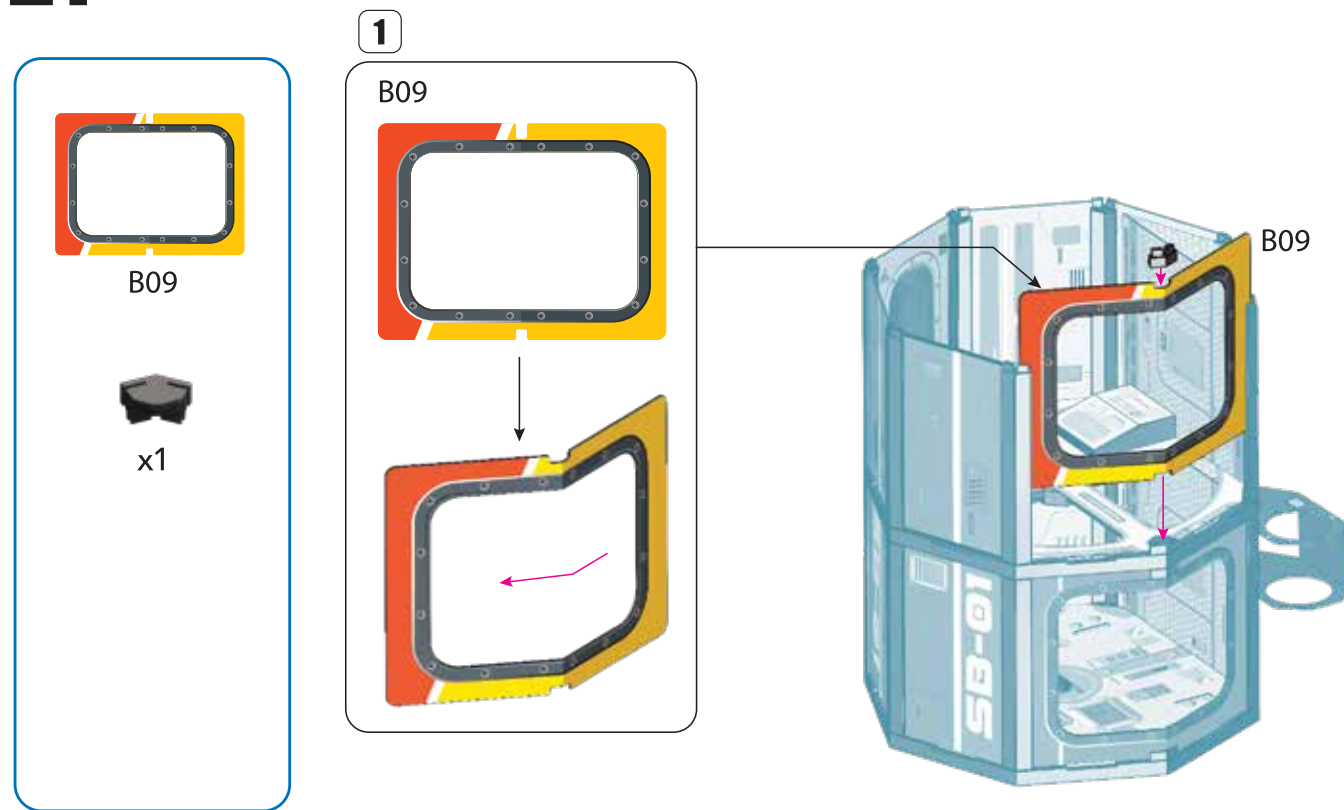

B

**STEP
22**

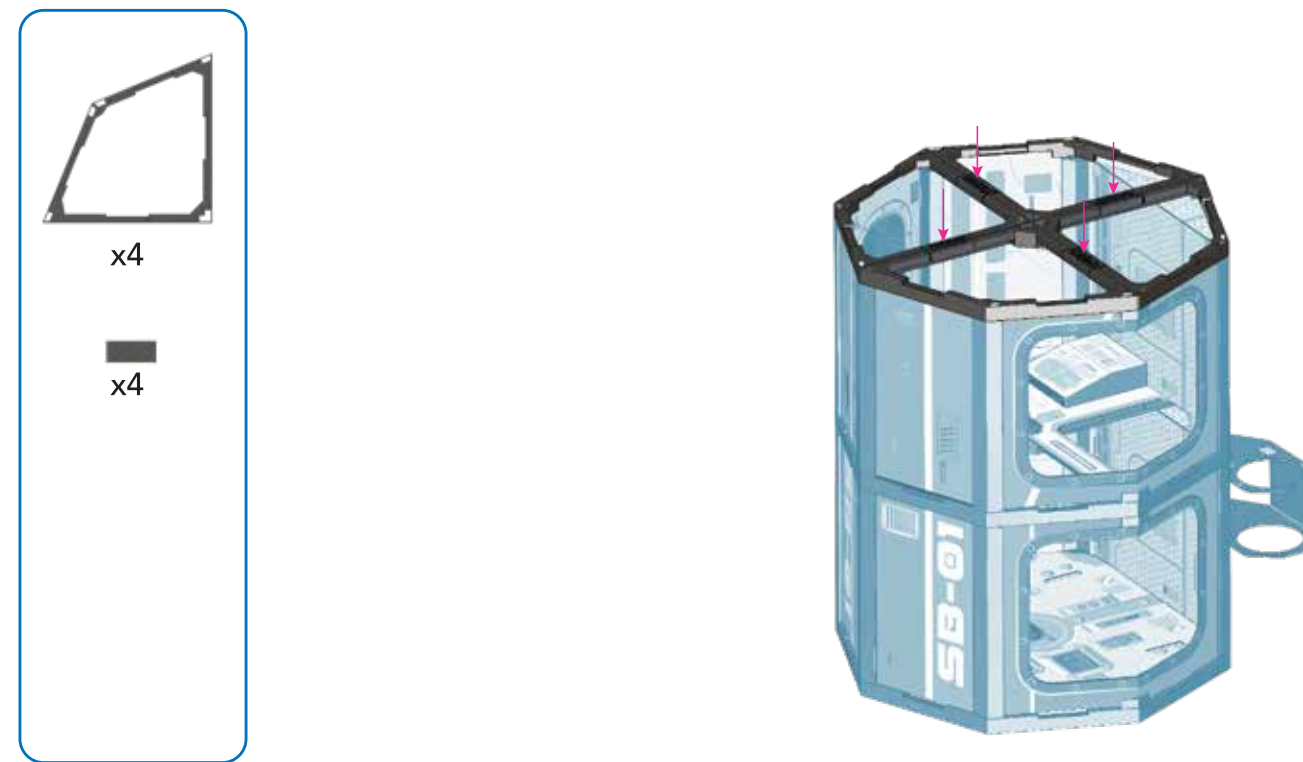

C

STEP 23

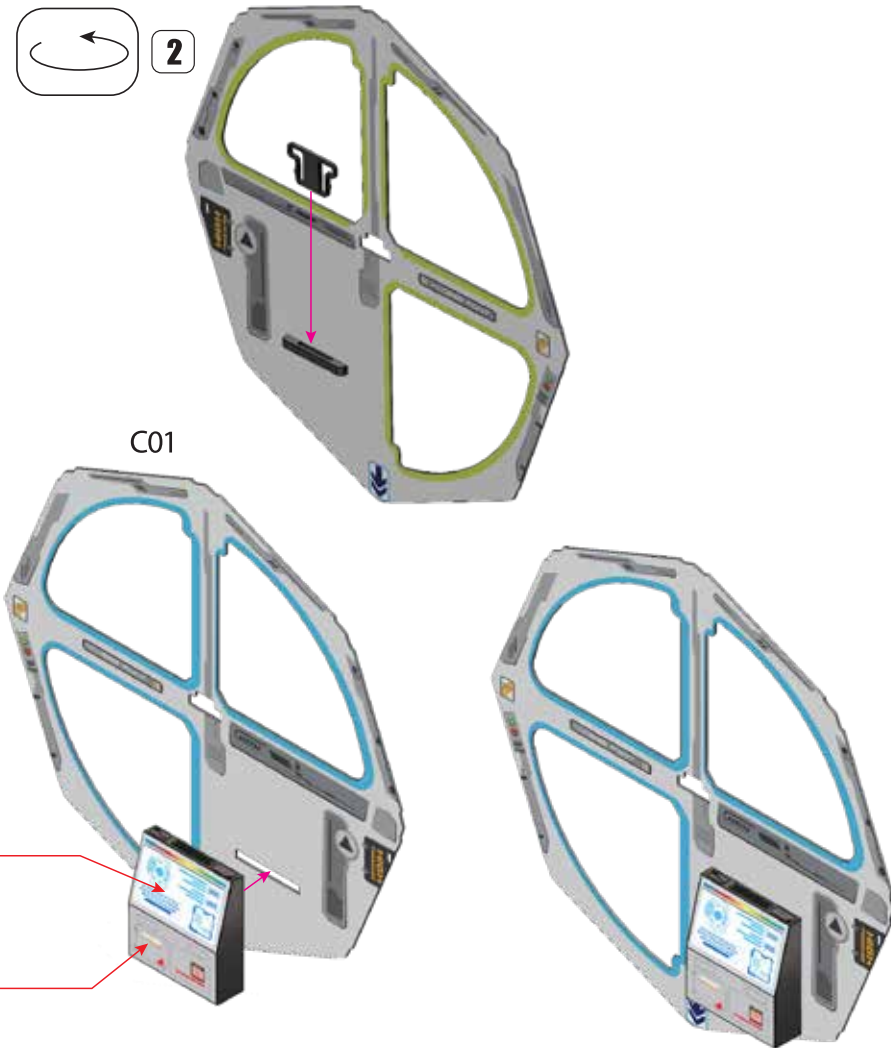
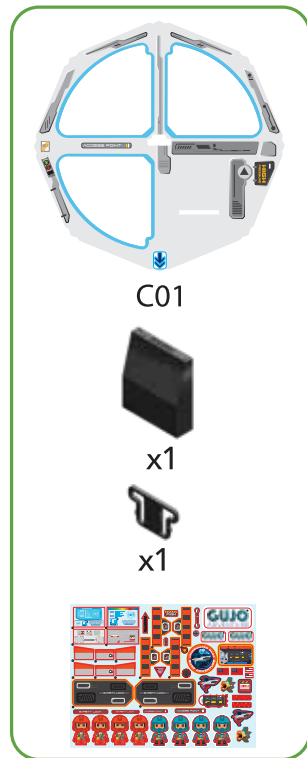

C

STEP 24

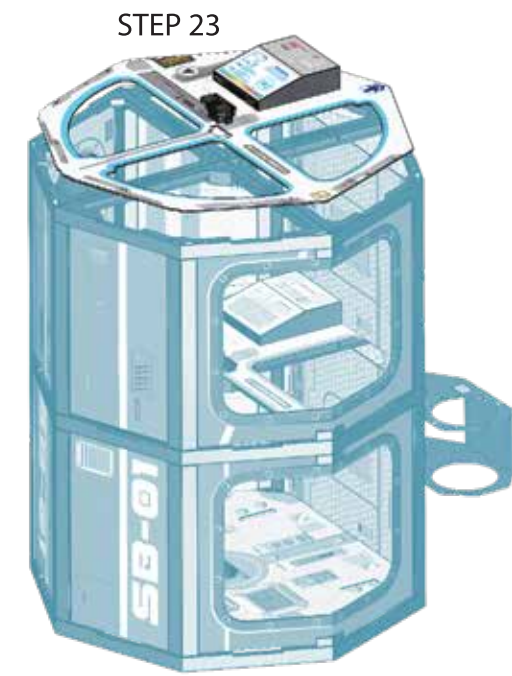

C

**STEP
25**

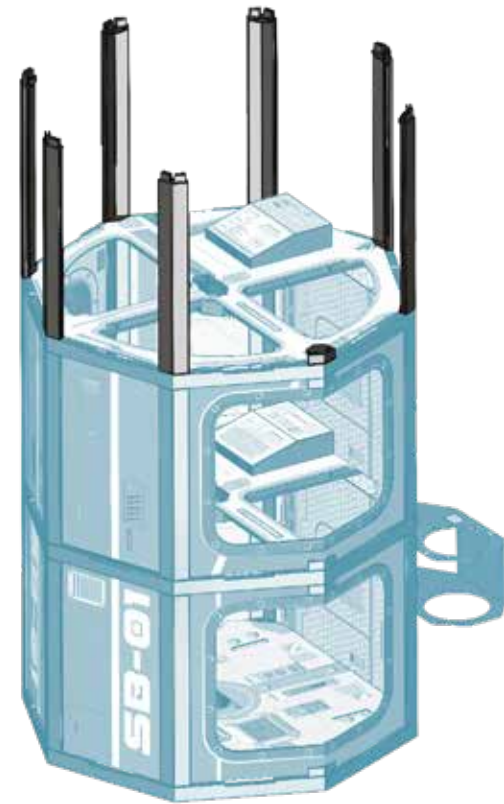
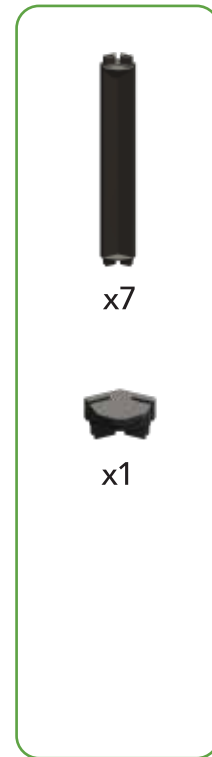

C

**STEP
26**

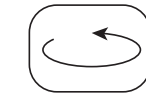
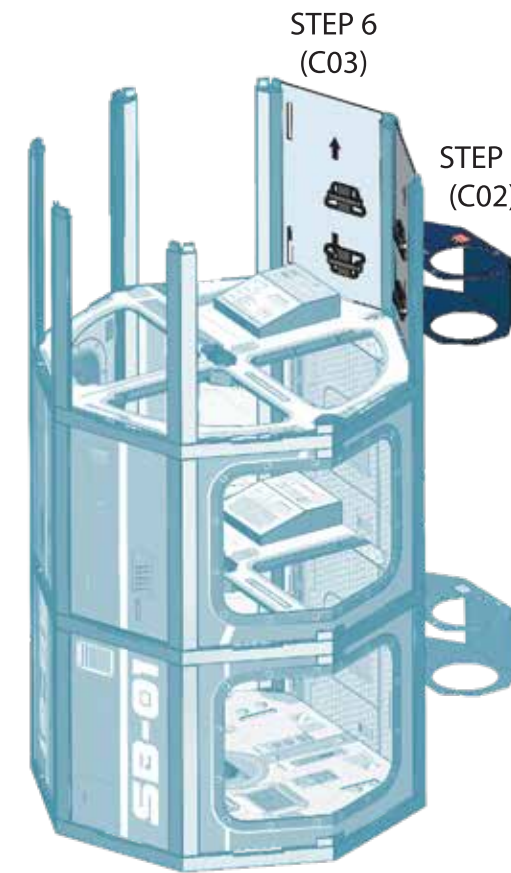
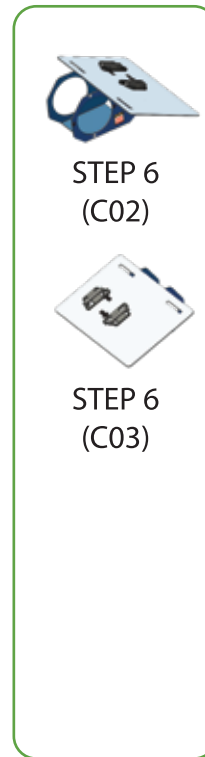

C

STEP
27

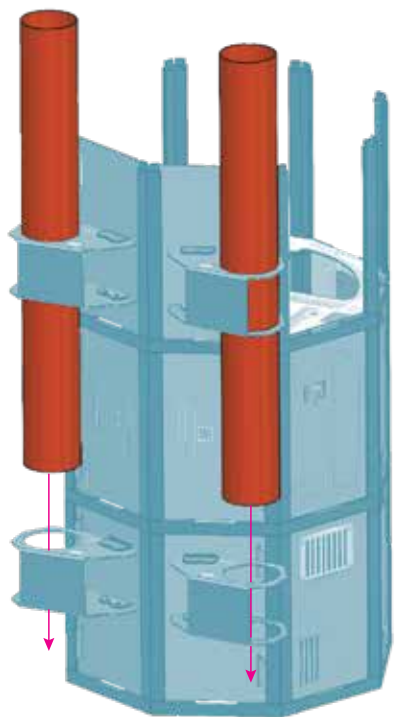
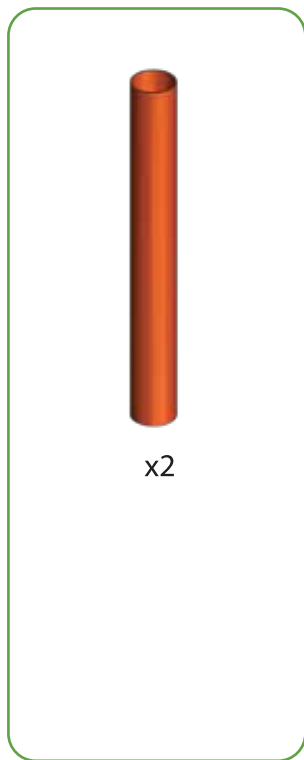

C

STEP
28

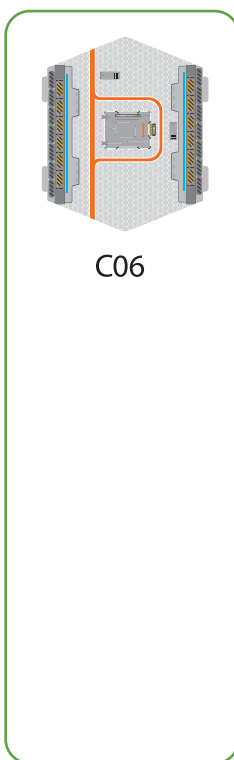

1

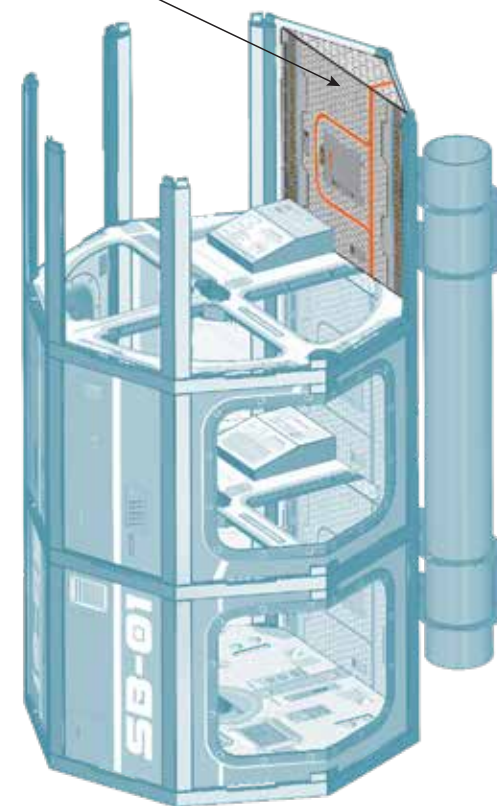
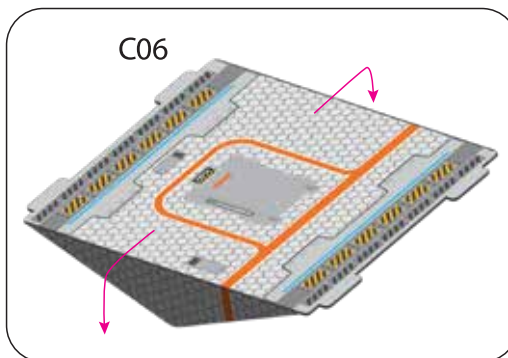

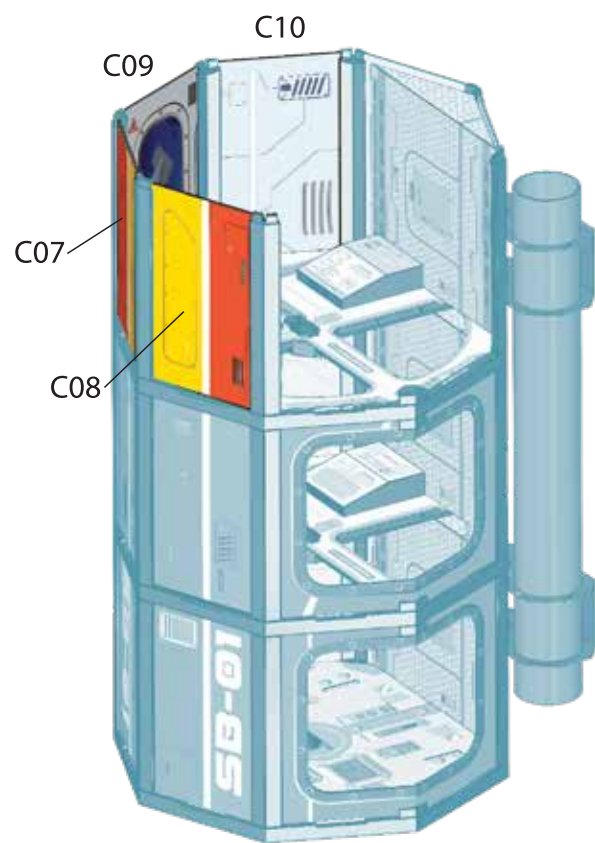
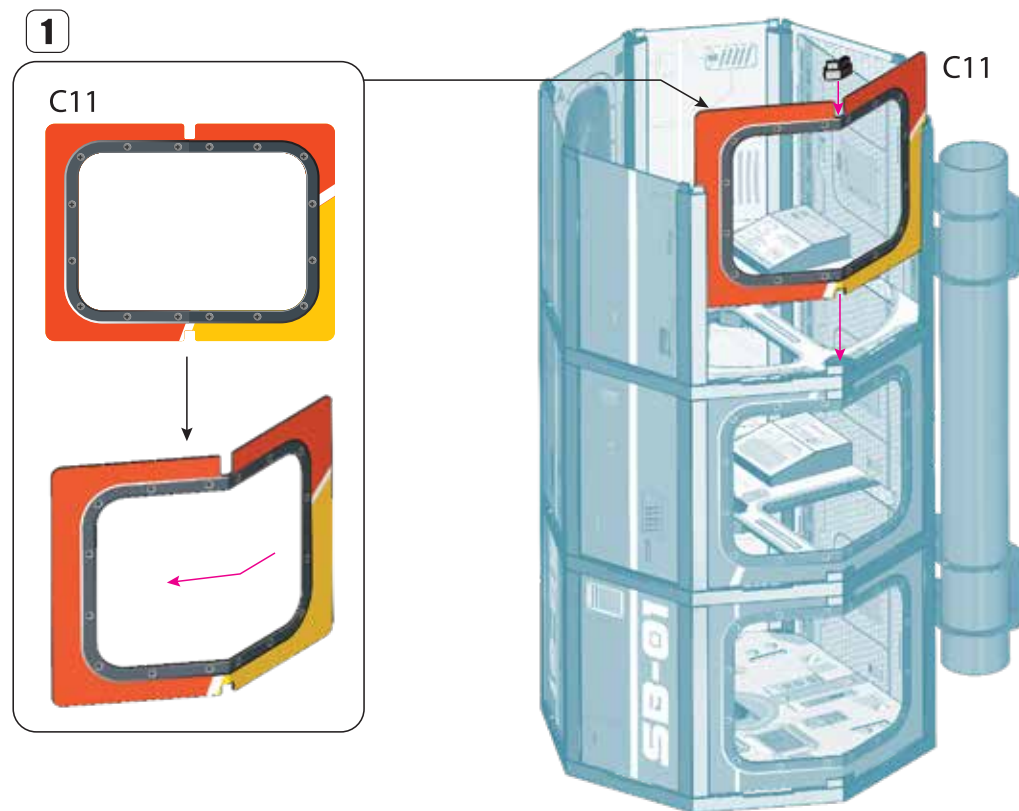
C**STEP
29****32****C****STEP
30****33**

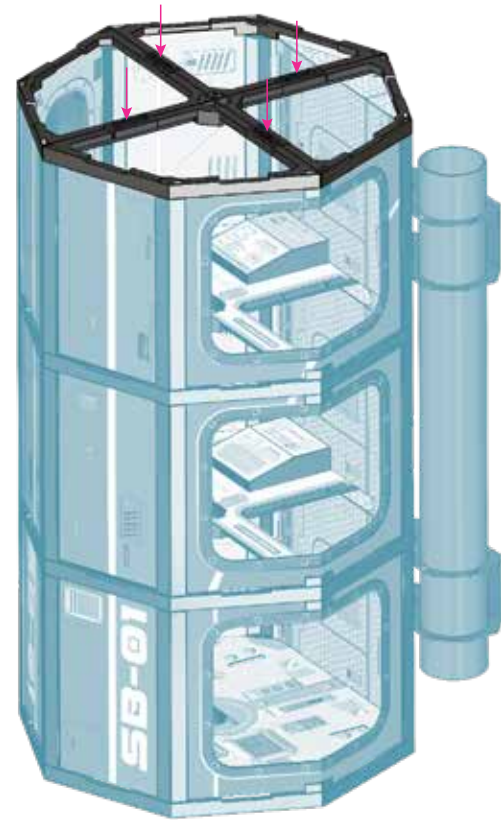
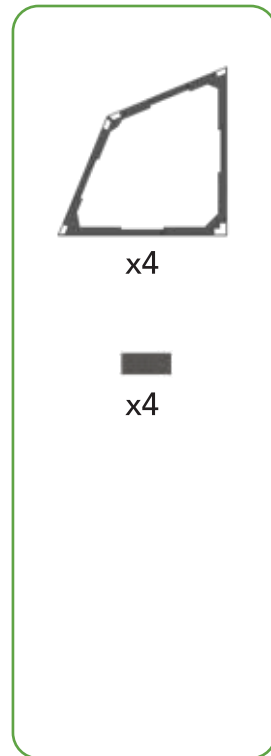
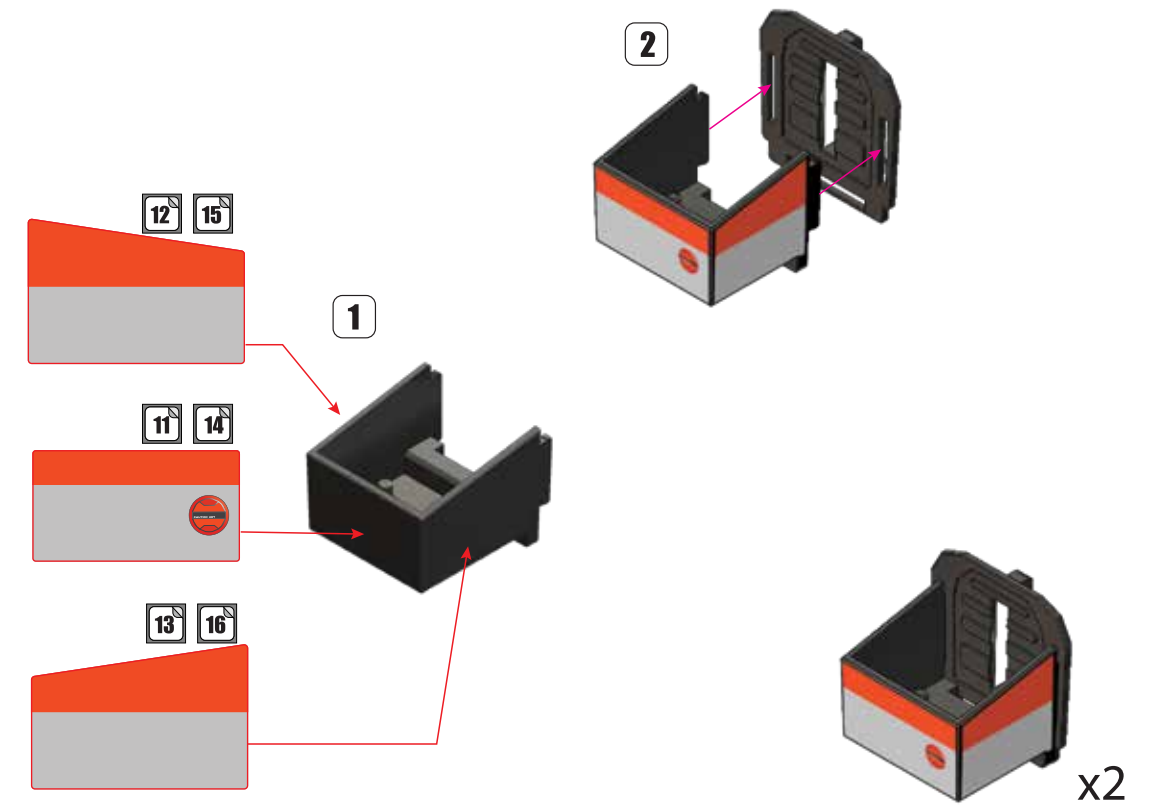
C**STEP
31****34****C****STEP
32****35**

C

STEP 33

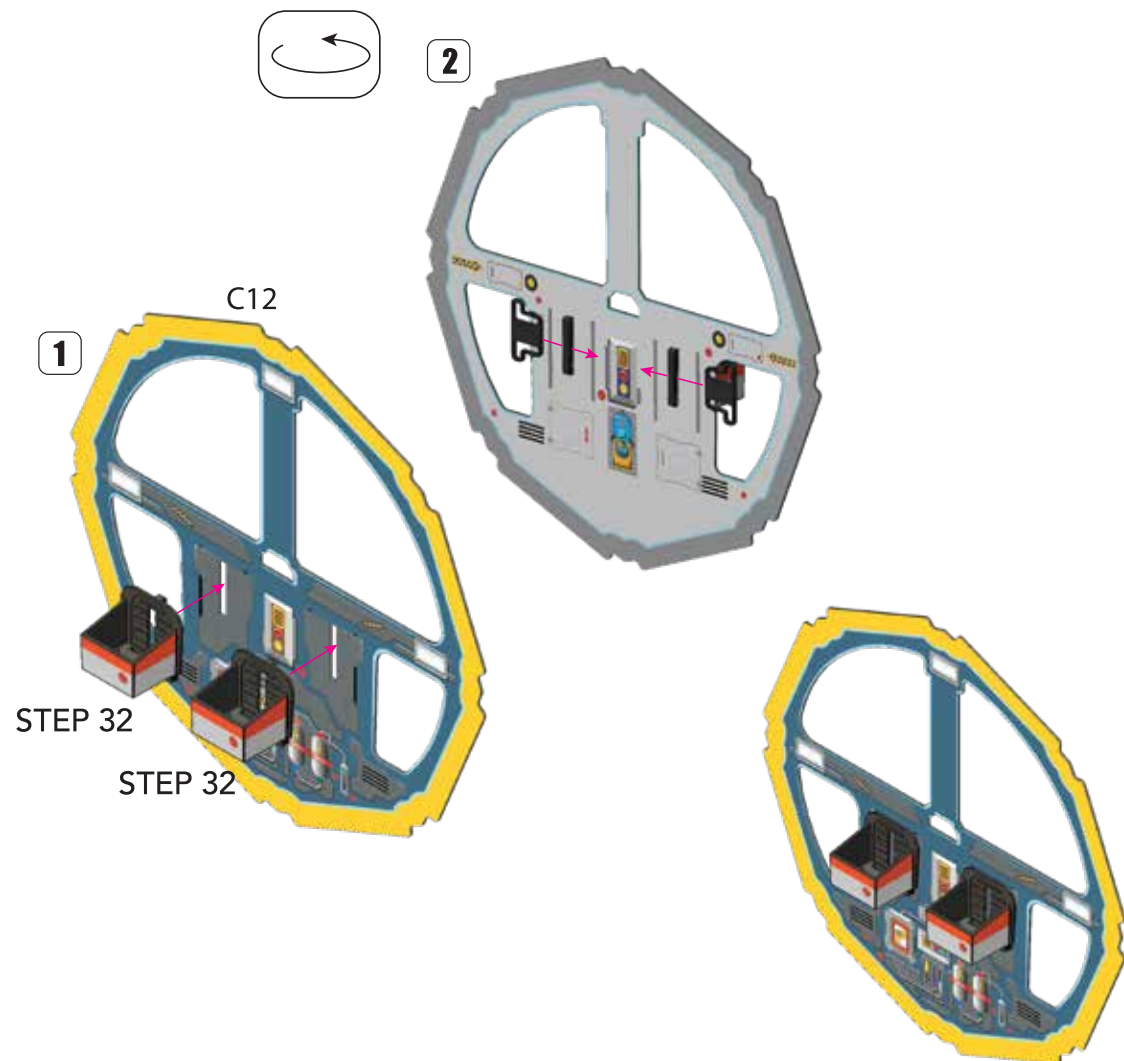

C

STEP 34

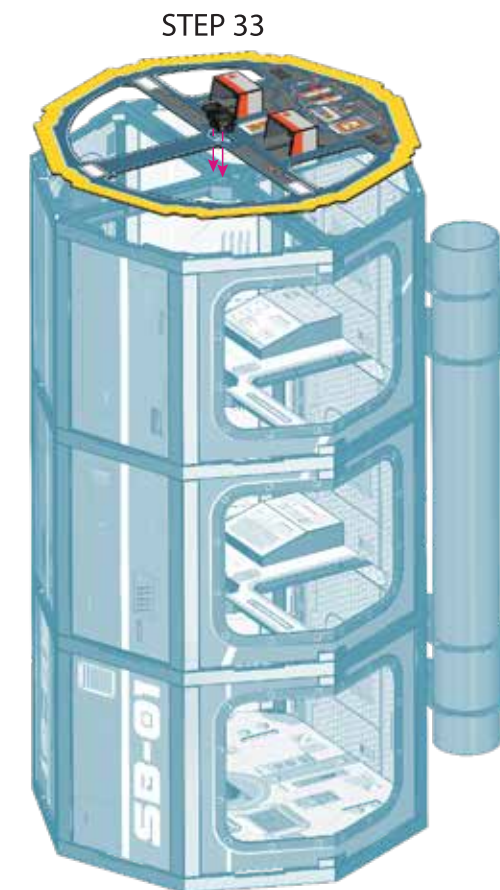

C

STEP
35

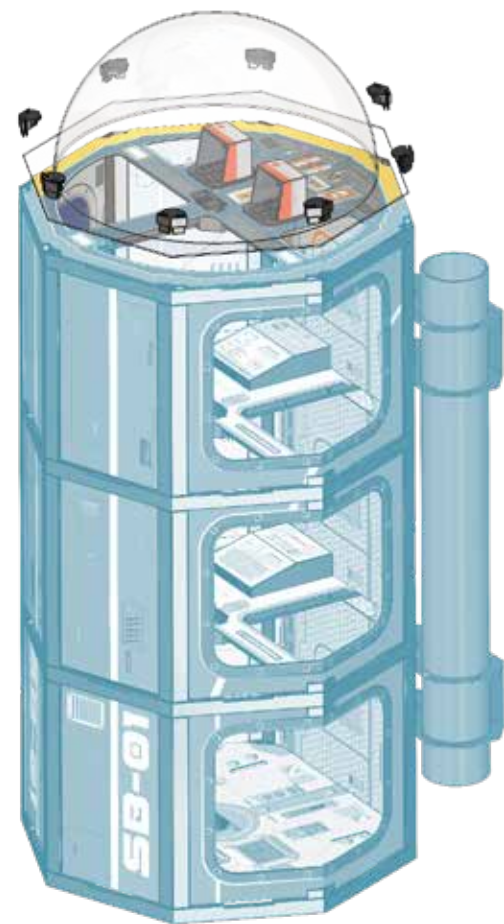
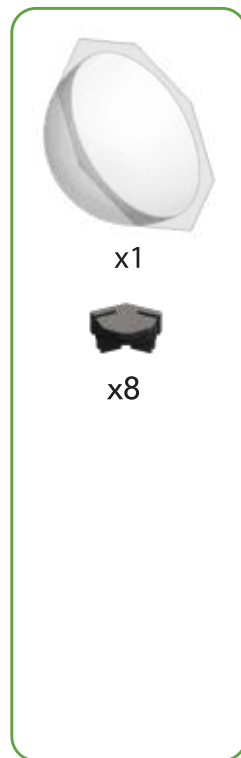

C

STEP
36

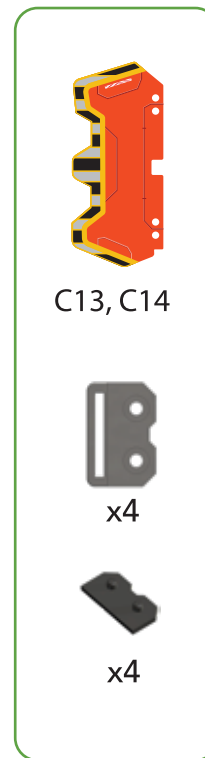

C13, C14

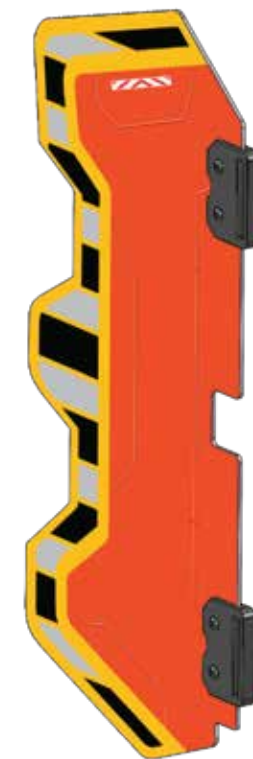

x2

C

**STEP
37**

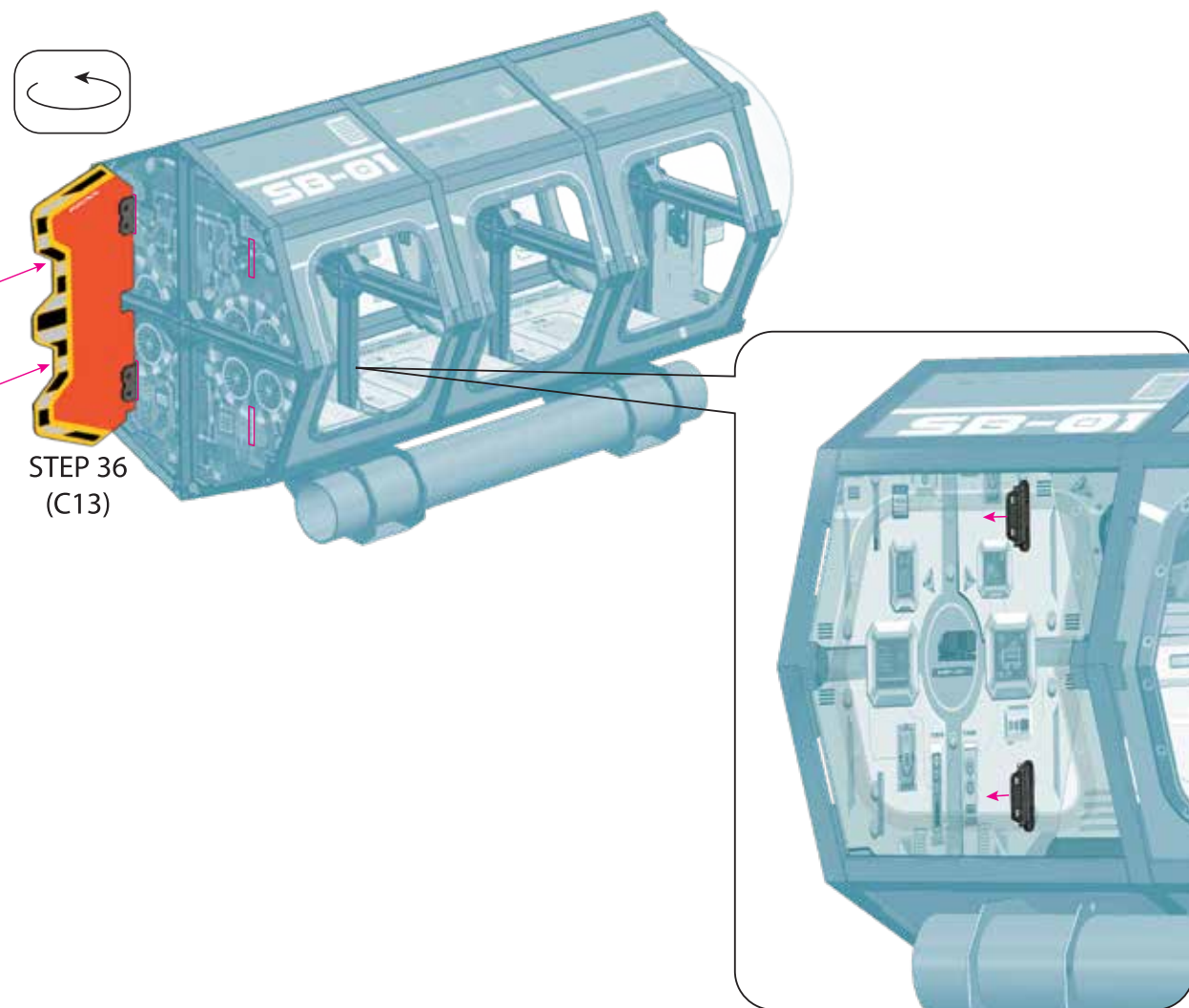

C

**STEP
38**

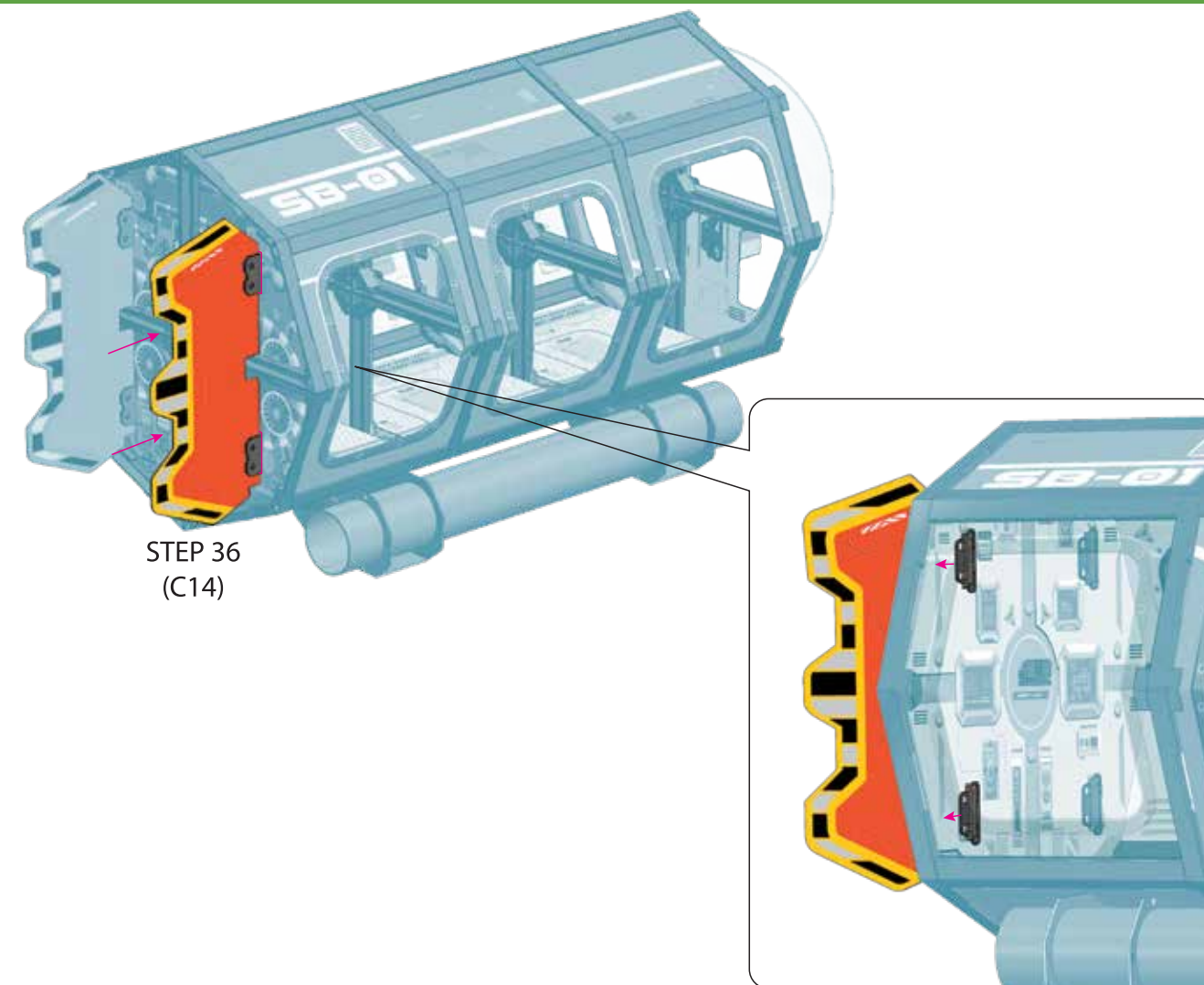

C

STEP
39

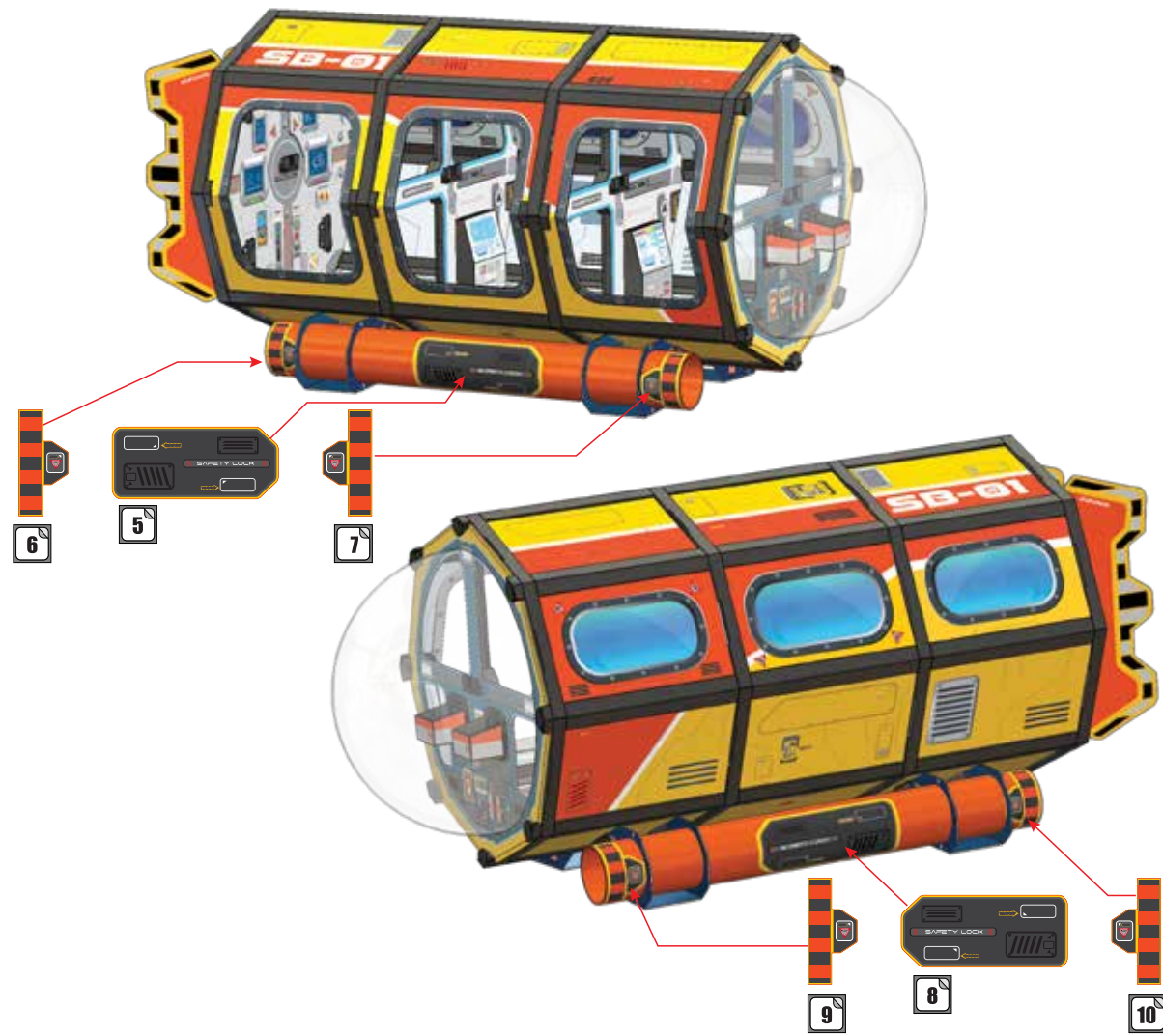



D

STEP
40

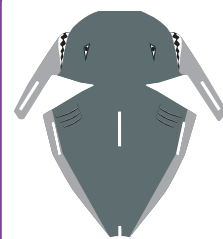

D01



D02

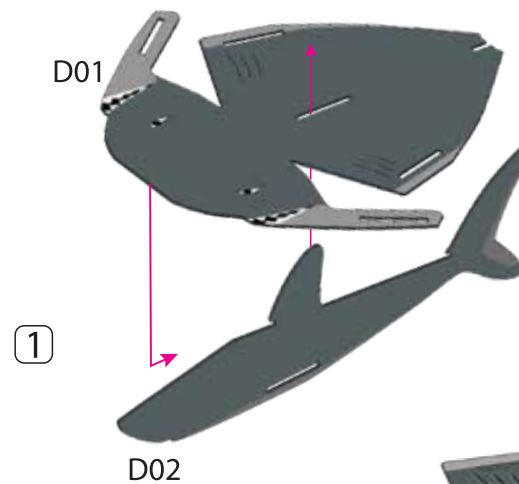

1

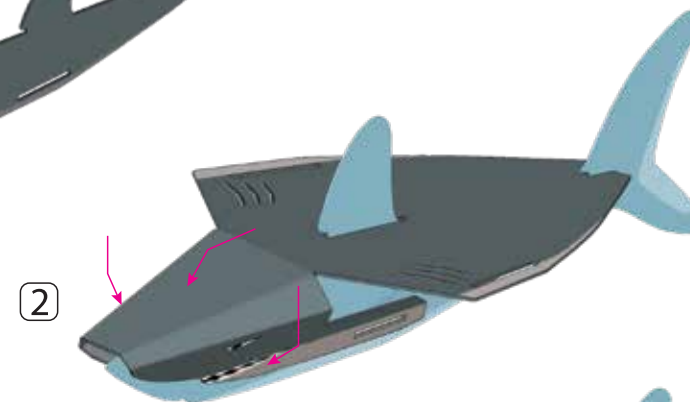

2

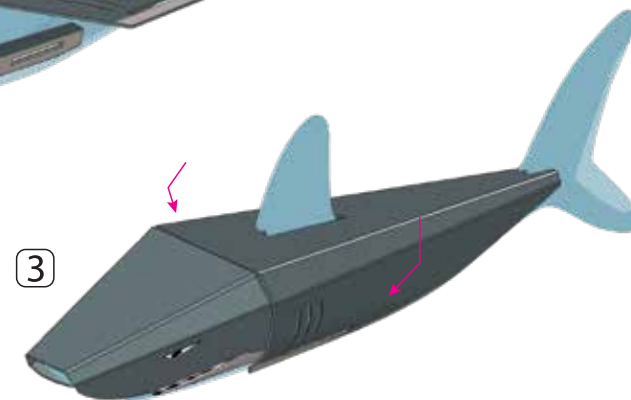

3

D

STEP
41



D03



x1

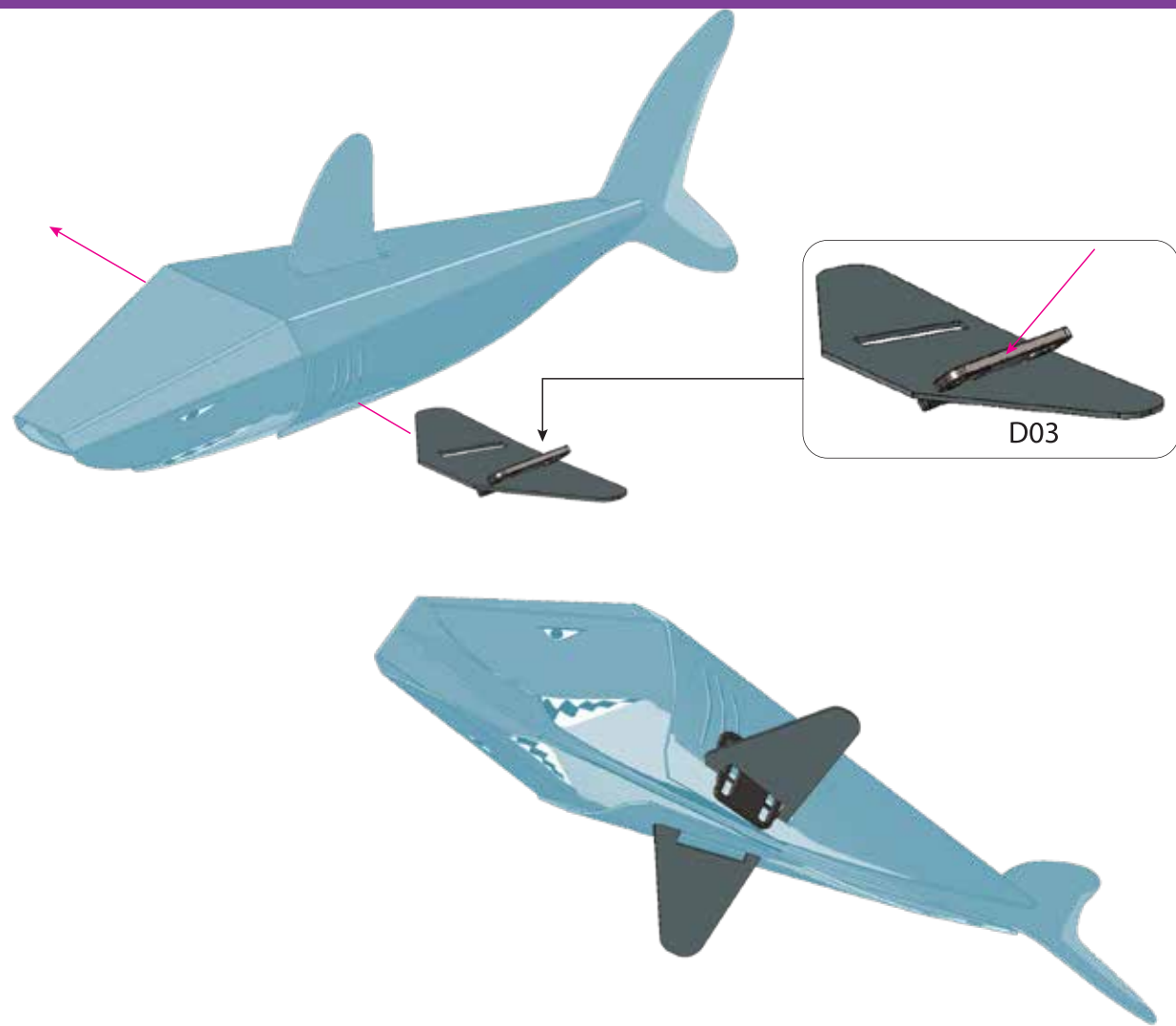

D

STEP
42



x1

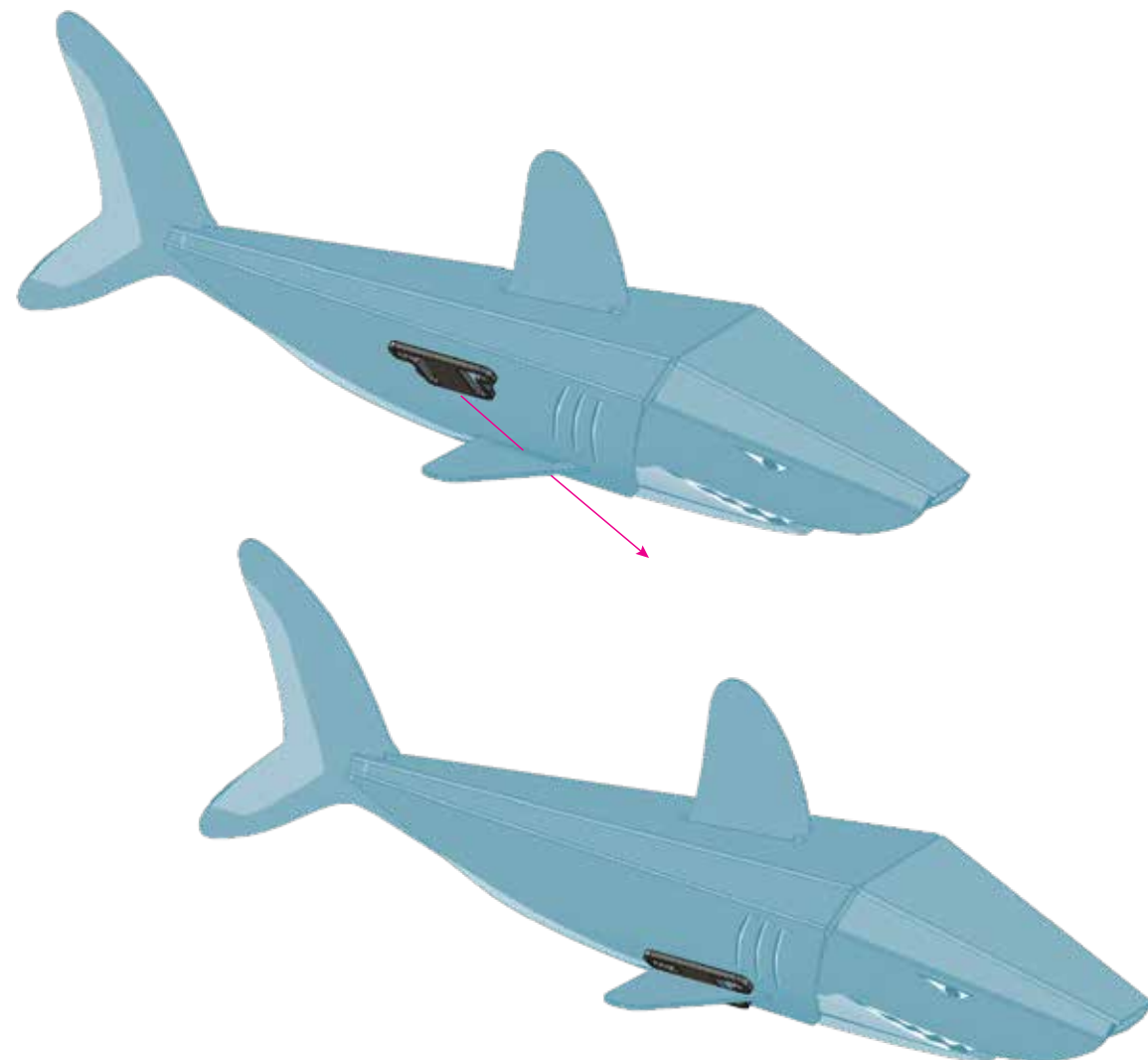

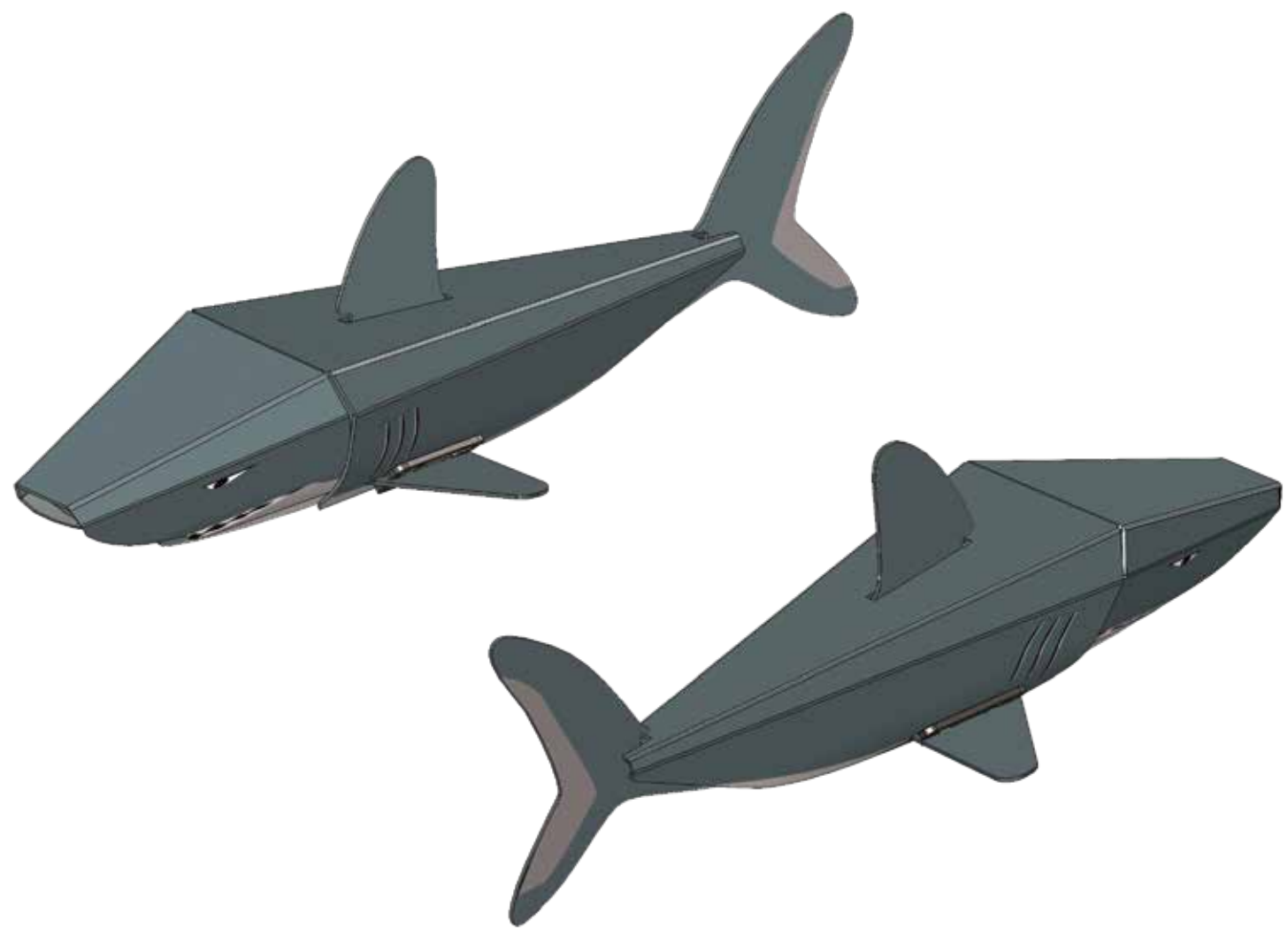

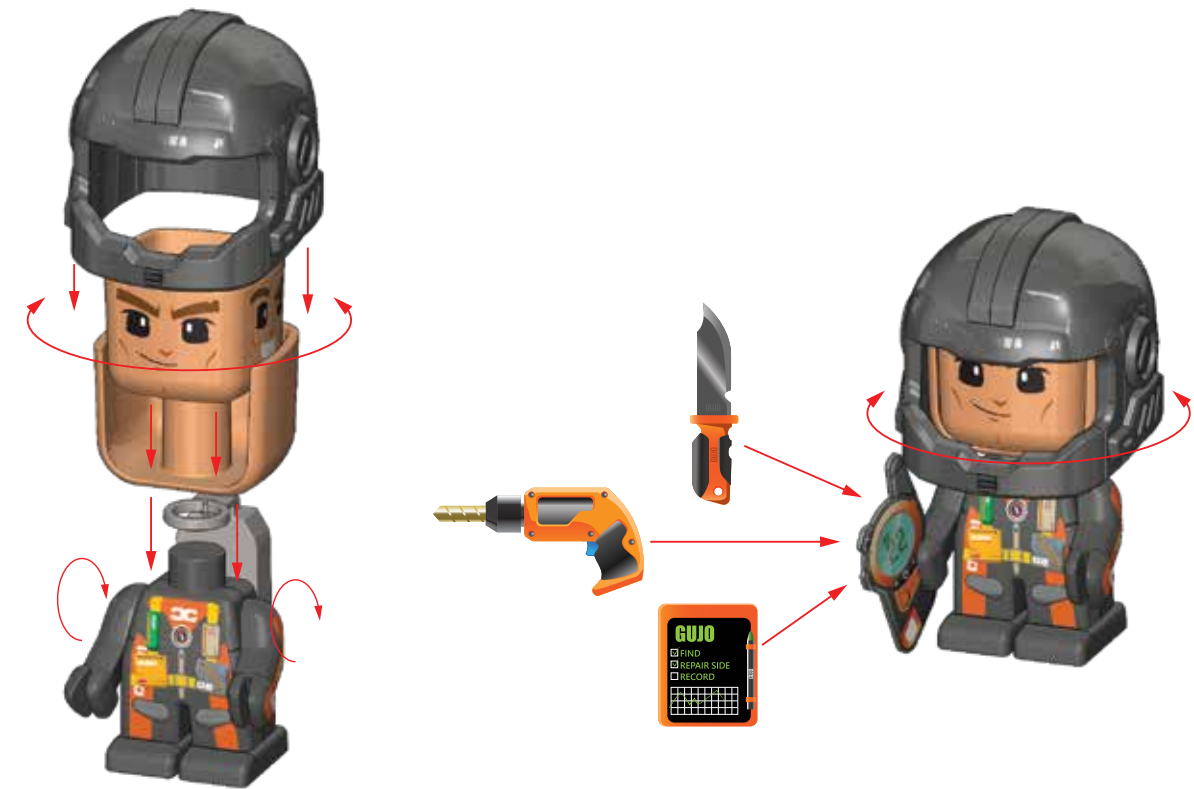

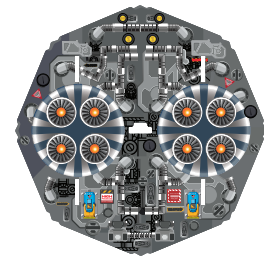

A01



A02



A03



A04



A05

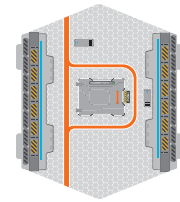

A06



A07



A08

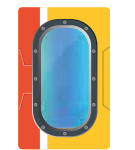

A09



A10

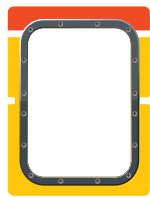

A11

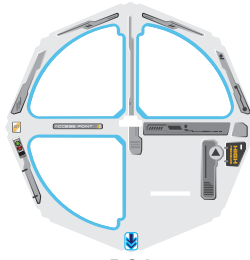

B01



B02



B03

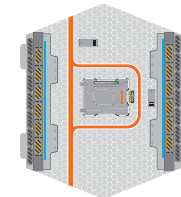

B04

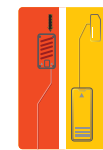

B05



B06



B07



B08



B09

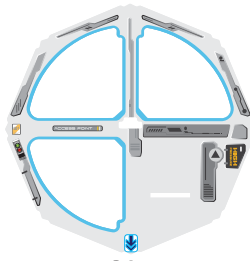

C01



C02



C03



C04



C05

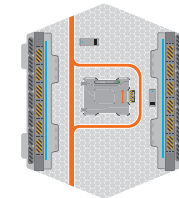

C06



C07

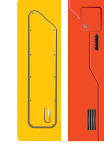

C08



C09



C10

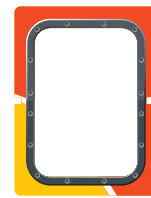

C11

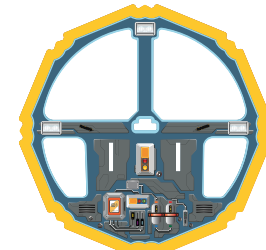

C12



C13



C14

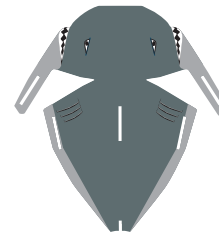

D01



x2

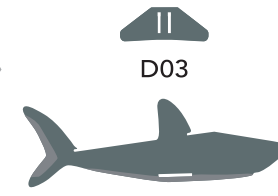

D02



x2

D03



x2



x16



x21



x16



x14



x8



x12



x12



x18



x1



x2



x1



x1



x1



x1

GUJO
ADVENTURE

**MORE GUJO
ADVENTURES**



MISSION MARS ROCKET



MARS SPACE BASE



LOST JUNGLE TEMPLE



UNDERWATER BASE

ALSO AVAILABLE



DEEP SEA SUBMARINE

GUJO ADVENTURE

 **LUKI LAB**

Designed in California.
Irvine, CA 92614 USA
Made in China.
www.gujoadventure.com
(888) 551-4258